

## NOTICE TO BIDDERS

NOTICE IS HEREBY GIVEN, that the Undersigned, on behalf of the Town of Schroon Town Clerk, will accept sealed bids at the Town of Schroon Town Hall until 1:00PM on March 19th, 2025 for the CONCRETE SIDEWALK REPLACEMENT 2025

The bids shall be opened and read aloud on March 19th, 2025 at 1:00pm at the Town Hall, 15 Leland Ave, Schroon Lake, New York 12870.

Bids are available at <https://www.co.essex.ny.us/bidders/publicbids.aspx> . Bids may be mailed or delivered to: Town of Schroon, 15 Leland Ave, P.O. Box 578, Schroon Lake NY 12870

All bids submitted in response to this notice shall be marked “**SEALED BID- CONCRETE SIDEWALK REPLACEMENT 2025**” clearly on the outside of the envelope.

Please address all questions, in writing, no later than noon March 13<sup>th</sup>, 2025 to Ethan Thompson, email: [buildingsgrounds@schroon.net](mailto:buildingsgrounds@schroon.net)

In the event that the Town of Schroon Office is closed the day of the Bid Opening due to unforeseen circumstances, the bid(s) will be opened the next business day that the Town of Schroon Office is open. The Bid Submission time will remain the same.

Town of Schroon affirmatively states that in regard to any contract entered into pursuant to these instructions, without regard to race, color, sex, religion, age, national origin, disability, sexual preference or Vietnam Era veteran status, disadvantaged and minority or women-owned business enterprises will be afforded equal opportunity to submit bids in response hereto.

Dated: February 18, 2025

Erica Hedden

Town Clerk

Town of Schroon

15 Leland Ave.

PO Box 578

Schroon Lake, New York 12870

(518) 532-7737

## INSTRUCTIONS TO BIDDERS

All bids submitted in response to this notice shall be marked "**SEALED BID – CONCRETE SIDEWALK REPLACEMENT 2025**" clearly on the outside of the envelope with the name and address of the bidder.

Effective December 30, 2024, all contractors and subcontractors submitting bids or performing construction work on public work projects or private projects covered by Article 8 of the Labor Law are required to register with the New York State Department of Labor (NYSDOL) under Labor Law Section 220-i. Please visit: <https://dol.ny.gov/contractor-and-subcontractor-landing>.

All bids shall be submitted on the bid form included in the package, and no other forms shall be accepted.

The Town reserves the right to reject any and all bids not considered to be in the best interest of the Town, and to waive any technical or formal defect in the bids which is considered by the Town to be merely irregular, immaterial, or unsubstantial.

Under New York State Labor Law, contractors and subcontractors must pay the prevailing rate of wage and supplements (fringe benefits) to all workers under a public work contract. Employers must pay the prevailing wage rate set for the locality where the work is performed. This applies to all laborers, workers or mechanics employed under a public work contract.

A Contract awarded pursuant to this notice shall be subject to the provisions of Sections 103-1, 103-b, 103-d and 103-g of the General Municipal Law.

The Town affirmatively states that in h-regard to any contract entered into pursuant to these instructions, without regard to race, color, sex, religion, age, national origin, disability, sexual preference or Vietnam Era veteran status, disadvantaged and minority or women-owned business enterprises, will be afforded equal opportunity to submit bids in response hereto.

Please address all questions in writing no later than noon March 13th, 2025 to Ethan Thompson, email: [buildingsgrounds@schroon.net](mailto:buildingsgrounds@schroon.net)

Addenda will be posted on the Essex County website. Interested vendors are urged to check before submitting their bid.

Each bidder will need to complete, sign, have notarized and return the following documents with their Bid:

- 1) Vendor Responsibility Questionnaire
- 2) Certification of Compliance with Iran Divestment Act
- 3) Non-Collusive Bidding Certification
- 4) Prevailing Wage Schedule
- 5) Appendix C Prevailing wage

The contract shall be completed by **October 27th, 2025**.

Payment will be made within thirty (30) days of delivery and receipt of invoice, and acceptance of work.

# SPECIFICATIONS

## **CONCRETE SIDEWALK REPLACEMENT 2025**

### **Project Description**

The Town of Schroon is seeking proposals for the replacement of concrete sidewalks and curbs. Pictures of the proposed replacement site(s) can be found in the appendices. The total footage of sidewalk and curb being replaced will be adjusted based on the winning bid and the amount the Town has budgeted for this work.

### **Scope of Work**

The proposed Work generally includes removal and replacement of concrete sidewalk; removal and replacement of concrete curb; saw cutting, removal and replacement of asphalt in roadway; saw cutting, removal and replacement of asphalt in driveway aprons; and site restoration of disturbed lawn areas with topsoil, seed and establishment of a good stand of grass. Responsibility for various Work items is further described below:

- 1. The Work by Contractor generally consists of, but is not necessarily limited to, the following:**
  - a. Pursuant to 16 N.Y.C.R.R. 753, Protection of Underground facilities, prior to non-emergency excavation, subsurface exploration of any kind, or installation below existing grade, the Contractor shall notify the one-call system of the date and location of the proposed work a minimum of two (2) days, not including the date of call, prior to work.
  - b. Install new concrete sidewalk, including dowels, reinforcing steel mesh, control joints, and expansion joints, at locations as directed by the Town and in accordance with details (See Appendix). All sidewalks to match existing width of abutting sidewalks, unless otherwise directed by the Town.
  - c. Install Town furnished Embedded Detectable Warning Units (NYSDOT Item 608.21) at sidewalk ramps to streets at locations shown on drawings or as indicated and directed by the Town and in accordance with details (See Appendix). Embedded Detectable Warning Units color shall be brick red.
  
- 2. The Work by the Town generally consists of, but is not necessarily limited to, the following:**
  - a. Pursuant to 16 N.Y.C.R.R. 753, Protection of Underground facilities, prior to non-emergency excavation, subsurface exploration of any kind, or installation below existing grade, the Town of Schroon shall notify the one-call system of the date and location of the proposed work a minimum of two (2) days, not including the date of call, prior to work.
  - b. Sawcut and remove driveway aprons as necessary.
  - c. Remove concrete sidewalk and subbase as necessary.

- d. Furnish and install subbase material. Compact and fine grade subbase material. Grades to be determined in the field to match existing conditions. Extreme care shall be taken while working adjacent to hedges, decorative fencing, and any type of retaining wall. Replace landscaping as it existed when work commenced.
- e. Furnish and install asphalt paving for disturbed driveways and roadways in strict accordance with details (see Appendix).
- f. Remove and replace stone curb as may be necessary and in accordance with details. (See Appendix)
- g. Restore disturbed lawn areas with 4" of topsoil and sod/seed as shown in the details and as necessary to establish a good stand of grass (See Appendix).
- h. Conduct final clean-up and restore all other areas to match conditions as they existed when work commenced.

### **Sequence And Budget Of Work**

1. The Town details the limits and sequence of Work divided into priority groups. The Contractor shall proceed with Work in a phased approach according to the priority as directed by the Town's designated representative and as budget will allow.
2. The Contractor shall notify the Town's designated representative at least 24-hours prior to commencing Work on any given day.
3. The Contractor shall notify the Town's designated representative upon reaching 75% of the \$40,000 funding level and shall not exceed the funding level without prior authorization by the Town.
4. The TOWN may suspend and/or terminate this Agreement at any time for convenience of TOWN, and CONTRACTOR shall be paid for Work performed and supplies used related to that Work up to that point.

### **Technical Specifications**

1. Concrete sidewalks shall meet the specifications outlined in section 608 of the NYSDOT Standard Specifications.
2. Concrete shall be 4000 PSI, air-entrained, pea stone, with a water-reducing admixture to provide a minimum 10% reduction of the design water content by using a normal range water-reducer.
3. Reinforcement shall be 6 gauge 6" x 6" wire mesh mat (no rolls). Drill and grout No. 8 dowels where new concrete meets existing concrete (omit if at expansion joint).
4. Sidewalks shall be 6" thick.
5. Control Joints shall be at roughly 5' intervals, 1/3 the depth of the concrete. Expansion joints shall be at maximum 25' intervals.
6. Exposed surfaces shall be broomed, and edges finished to match existing sidewalk.
7. Concrete shall be coated with a clear curing compound within 30 minutes of finishing.

### **Maintenance Of Traffic**

1. The Town shall provide all facilities and traffic controls needed to allow safe conduct of the Work while maintaining public use of the site, including, but not necessarily limited to, warning signs, barricades, delineators, lights, cones, etc. Traffic control shall be the responsibility of the Town.

### **Additional Information**

1. Before submitting a proposal, all contractors are advised to personally inspect the project site. **You may schedule a site visit until 7 days before the opening date by contacting Ethan Thompson in writing at [buildingsgrounds@schroon.net](mailto:buildingsgrounds@schroon.net).**
2. The awarded Contractor shall not assign the contract, or any part thereof, without written approval from the Town.
3. All contractors submitting bids are required to conform to all current NYS prevailing wage laws. The Town has applied for and has received a PRC number (2025002012) for this project, which has been included with this document. The successful Contractor is responsible for complying with all current labor rates and regulations throughout the duration of any contract resulting from this document. Current rates are available by calling the NYS Department of Labor at (585) 258-4505. Rates are also available via the internet at: <https://apps.labor.ny.gov/wpp/publicViewProject.do?method=showIt&id=1533640>.
4. The Town of Schroon works on a voucher system. This is the Town's guarantee of payment for services and products delivered. Under no circumstances will the Town issue any prepayment prior to delivery and acceptance of services and products.
5. The Town of Schroon shall pay invoices at net 30 days after receipt of invoice and acceptance of work.
6. Any violation of the terms, conditions, requirements and/or non-performance of the agreement resulting from this RFP shall result in immediate cancellation. The agreement may be cancelled by the Town for any other reason(s) upon thirty (30) days written notice.

### **Submittal Requirements**

- Bid Form
- Vendor Responsibility Questionnaire
- Certification of Compliance with Iran Divestment Act
- Non-Collusive Bidding Certification
- Prevailing Wage Schedule
- Appendix C Prevailing Wage

# “New Requirement”

## Public Work Contractor and Subcontractor Registry

**Starting December 30, 2024**, all contractors and subcontractors submitting bids or performing construction work on public work projects or private projects covered by Article 8 of the Labor Law are required to register with the New York State Department of Labor (NYSDOL) under Labor Law Section 220-i.

<https://dol.ny.gov/contractor-and-subcontractor-landing>

The law defines a “contractor” as any entity entering into a contract to perform construction, demolition, reconstruction, excavation, rehabilitation, repair, installation, renovation, alteration, or custom fabrication. The law defines “subcontractor” as any entity subcontracting with a contractor to perform construction, demolition, reconstruction, excavation, rehabilitation, repair, installation, renovation, alteration, or custom fabrication, which is subject to Article 8 of the Labor Law. Contractors are responsible for verifying that any subcontractors they work with are registered.

**Contractors need to register before submitting any new bids or commencing new work on a covered project on or after December 30, 2024. Subcontractors need to register before commencing new work on a covered project on or after December 30, 2024.** NYSDOL encourages all contractors and subcontractors to register as soon as possible to obtain a Certificate of Registration to avoid negatively impacting a bidding period or project schedule.

The Bureau of Public Work & Prevailing Wage Enforcement at the New York State Department of Labor is responsible for enforcing prevailing wage laws in New York State.

The Bureau of Public Work & Prevailing Wage Enforcement publishes the annual prevailing wage schedule every year on July 1. To find information about the prevailing wage rate for your area, or to find contact information for your local Public Works and Prevailing Wage Enforcement District Office, please visit Bureau of Public Work and Prevailing Wage Enforcement website or send an email to [labor.sm.pwask@labor.ny.gov](mailto:labor.sm.pwask@labor.ny.gov).

## Electronic Certified Payroll Submissions in 2025

There is a new subsection 220-j in Article 8, which will require the Department of Labor to develop a publicly accessible online database of electronic certified payroll records, which will be available no later than **December 31, 2025**.

All submissions of certified payroll records will be collected electronically through this forthcoming database, starting when the system is completed in 2025.

Please watch the NYS Department of Labor website for additional information.

# Appendices

1. Insurance Addendum
2. Concrete Curb & Sidewalk Details
3. NYSDOT Standard Sheets 608-01 “Pedestrian Facilities”
4. NYSDOT Standard Sheets 608-03 “Residential and Minor Commercial Driveway”
5. Prevailing Wage PRC

## 1. Insurance Addendum

### INSURANCE AGREEMENT – CONTRACTORS

1. Notwithstanding any terms, conditions or provisions, in any other writing between the parties, the contractor hereby agrees to effectuate the naming of the TOWN OF SCHROON as an additional insured on the CONTRACTOR'S insurance policies, with the exception of workers' compensation and N.Y. State Disability insurance.
2. The policy naming the TOWN OF SCHROON as an additional insured shall:
  - a. Be an insurance policy from an A.M. Best rated "Secure" or better insurer, authorized to conduct business in New York State. A New York licensed insurer is preferred. The decision to accept specific insurers lies exclusively with the TOWN OF SCHROON.
  - b. State that the organization's coverage shall be primary and non-contributory coverage for the TOWN OF SCHROON, its board, officers, employees and volunteers.
  - c. Additional insured status shall be provided by standard or other endorsements that extend coverage to the TOWN OF SCHROON for both on-going and completed operations. The decision to accept an endorsement rests solely with the TOWN OF SCHROON. A completed copy of the endorsements must be attached to the certificate of insurance.
  - d. The certificate of insurance must describe the specific services provided by the contractor (e.g., roofing, carpentry, plumbing) that are covered by the liability policies.
  - e. At the TOWN OF SCHROON's request, the CONTRACTOR shall provide a copy of the declaration page of the liability and umbrella policies with a list of endorsements and forms. If so requested, the CONTRACTOR will provide a copy of the policy endorsements and forms.
  - f. A fully completed New York Construction Certificate of Liability Insurance Addendum (ACORD 855 2014/05) must be included with the certificates of insurance.
4. The CONTRACTOR agrees to indemnify the TOWN OF SCHROON for any applicable deductibles and self-insured retentions.
5. Required Insurance:
  - a. **Commercial General Liability Insurance**  
\$1,000,000 per occurrence/ \$2,000,000 general and products/completed operations aggregates. The general aggregate shall apply on a per-project basis.



- b. **Automobile Liability**  
\$1,000,000 combined single limit for owned, hired and borrowed and non-owned motor vehicles.
- c. **Workers' Compensation, Employers Liability and NYS Disability Insurance**  
Statutory Workers' Compensation, Employers' Liability Insurance and NYS Disability Insurance for all employees. Proof of coverage must be on the approved specific form, as required by the New York State Workers' Compensation Board. ACORD certificates are not acceptable.
- d. **Excess Insurance**  
\$1,000,000 each Occurrence and Aggregate. Excess coverage shall be on a follow-form basis.

6. CONTRACTOR acknowledges that failure to obtain such insurance on behalf of the TOWN OF SCHROON constitutes a material breach of contract and subjects it to liability for damages, indemnification and all other legal remedies available to the TOWN OF SCHROON. The CONTRACTOR is to provide the TOWN OF SCHROON with a certificate of insurance, evidencing the above requirements have been met, prior to the commencement of work or use of facilities.

# CONSTRUCTION DETAIL

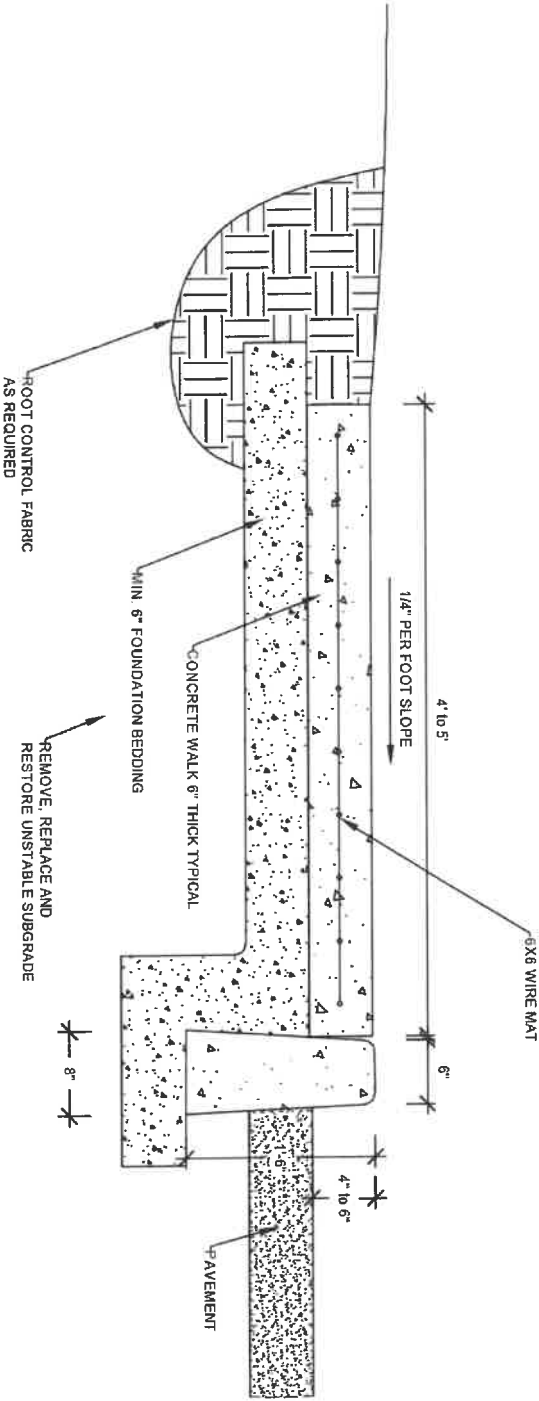

# HIGHWAY WORK PERMITS SIDEWALK WITHIN NYS RIGHT-OF-WAY (N.T.S.)

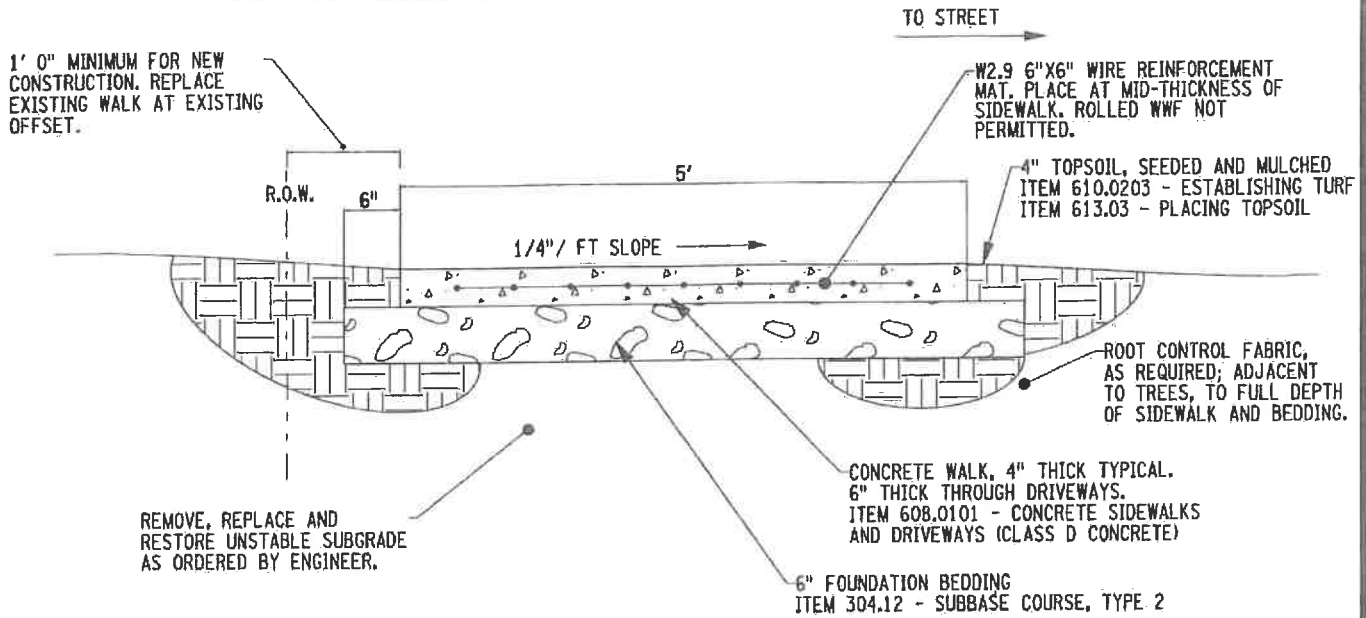

**CROSS-SECTIONAL VIEW**

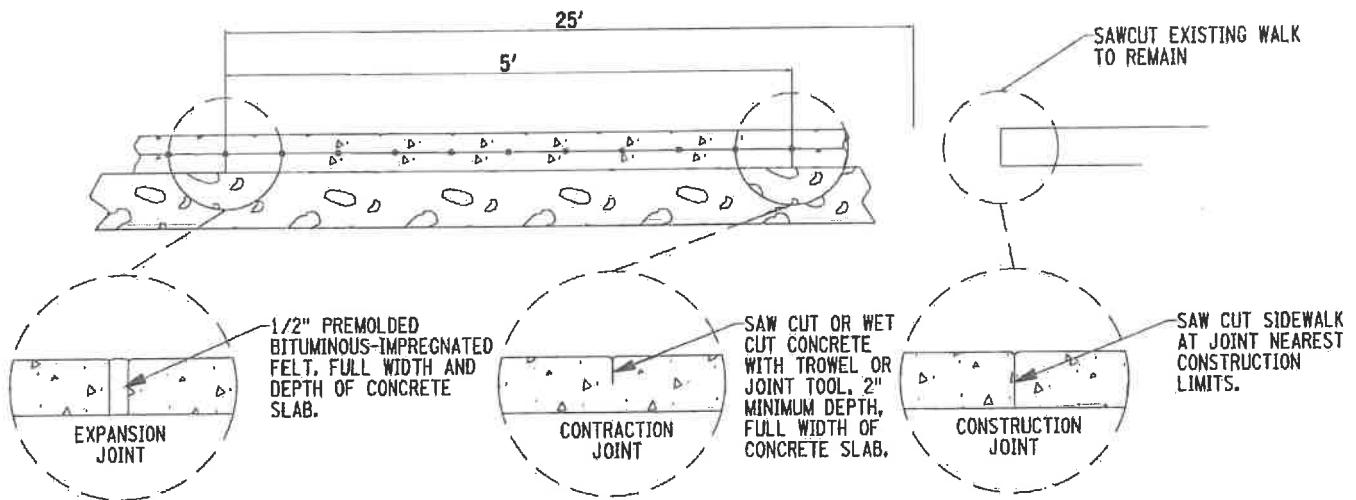

**PROFILE VIEW**

**NOTES:**

- 1) THE GRAVEL OR STONE BASE SHALL BE PLACED ON A WELL GRADED AND COMPACTED SUBGRADE. THE GRAVEL OR STONE BASE SHALL BE THOROUGHLY COMPACTED.
- 2) ALL EXPOSED SURFACES SHALL BE BROOMED AND EDGES FINISHED WITH A 1/4" RADIUS EDGING TOOL. THE FINISHED CONCRETE SURFACE SHALL BE TREATED WITH A CLEAR, NON YELLOWING CURING COMPOUND.
- 3) NO CONCRETE SHALL BE PLACED BEFORE APRIL 20TH, OR AFTER OCTOBER 31ST. NO CONCRETE SHALL BE PLACED UNLESS THE AMBIENT AIR AND BASE MATERIAL SURFACE TEMPERATURE IS ABOVE 40 DEGREES.
- 4) ALL WORK SHALL CONFORM TO NYSDOT SPECIFICATIONS.
- 5) ALL WORK SHALL CONFORM TO ADA REQUIREMENTS.



STATE OF NEW YORK  
DEPARTMENT OF TRANSPORTATION



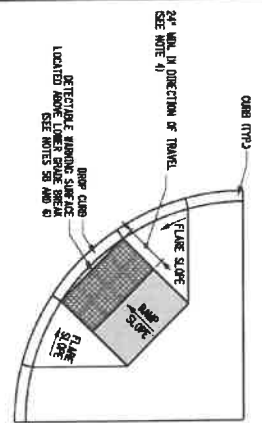

DETECTABLE WARNING SURFACE PLACEMENT - OPTION 1

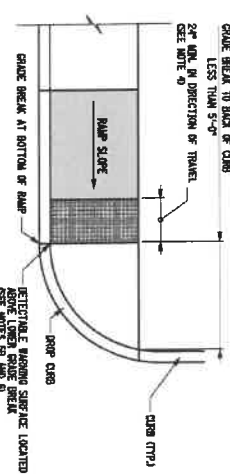

DETECTABLE WARNING SURFACE PLACEMENT - OPTION 2

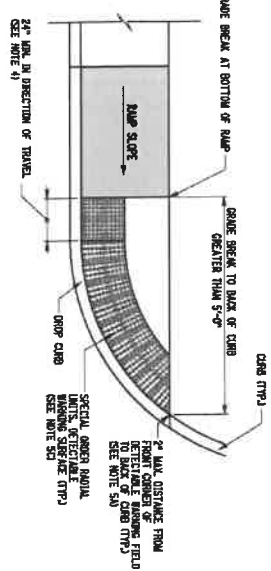

DETECTABLE WARNING SURFACE PLACEMENT - OPTION 3

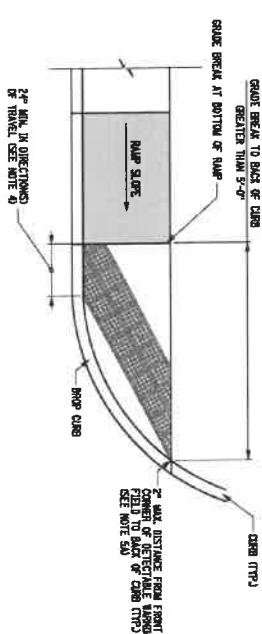

DETECTABLE WARNING SURFACE PLACEMENT - OPTION 4

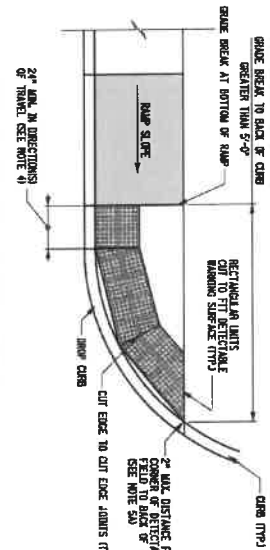

DETECTABLE WARNING SURFACE PLACEMENT - OPTION 5

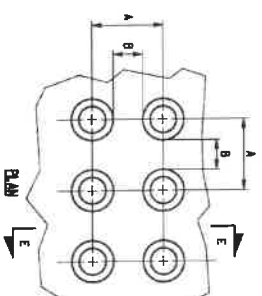

TRUNCATED DOME DIMENSIONS	MIN. DIM.	MAX. DIM.
A	1.5"	2.4"
B	0.65"	1.5"
C	50% - 65% OF D. DIA.	
D	0.2"	1.4"

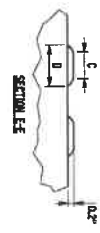

DETECTABLE WARNING SURFACE DOME TRUNCATED DOME DETAILS

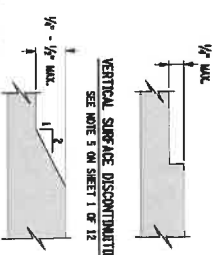

VERTICAL SURFACE DISCONTINUITIES  
 SEE NOTE 5 ON SHEET 1 OF 12

**DETECTABLE WARNING NOTES**

- DETECTABLE WARNING SURFACES (DWS) SHALL BE PROVIDED AT THE FOLLOWING LOCATIONS ON PEDESTRIAN ACCESS ROUTES:
  - CURB RAMP AND BLENDED TRANSITIONS AT PEDESTRIAN STREET CROSSINGS.
  - PEDESTRIAN BRIDGE ISLANDS WHERE THE LENGTH OF THE PEDESTRIAN ACCESS ROUTE ACROSS THE BRIDGE ISLAND IS GREATER THAN OR EQUAL TO 6'.
  - PEDESTRIAN AT-GRADE RAIL CROSSINGS NOT LOCATED WITHIN A STREET OR HIGHWAY.
- DETECTABLE WARNING SURFACES SHALL BE PROVIDED WHERE THE PEDESTRIAN ACCESS ROUTE CROSSES WATERWAYS WITH SIGNAL, YIELD OR STOP CONTROL.
- WITH THE EXCEPTION OF THE "DETECTABLE WARNING SURFACE TRUNCATED DOME DETAILS" DETECTABLE WARNING DOWNS ON THIS SHEET ARE NOT DEPICTED TO SCALE.
- DETECTABLE WARNING FIELD SIZE SHALL EXTEND 24" MINIMUM IN THE DIRECTION OF FOOTING TRAVEL ACROSS THE FULL WIDTH OF THE CURB RAMP OR FLUSH SURFACE, EXCLUDING ANY FLARED SIDES.
  - SOME DETECTABLE WARNING PRODUCTS REQUIRE A CONCRETE BORDER FOR PROPER INSTALLATION. BORDERS CANNOT BE INCLUDED AS PART OF THE 24" MINIMUM DIMENSION DESCRIBED IN NOTE 4.
  - WHEN PLACED AT THE BACK OF CURB, DETECTABLE WARNING FIELDS SHOULD BE PLACED AS CLOSE TO THE BACK OF CURB AS PRACTICABLE. BOTH FRONT CORNERS OF THE DETECTABLE WARNING FIELD SHALL NOT BE MEASURED MORE THAN 2" FROM THE BACK OF CURB. WHERE THE BACK OF CURB EDGE IS TOOK TO PROVIDE A RADIUS, THE BORDER DIMENSION SHALL BE MEASURED FROM THE INSIDE EDGE OF THE CURB RADIUS, WHERE CURB IS NOT USED, THE EDGE OF PAVEMENT SHALL BE SUBSTITUTED FOR THE BACK OF CURB FOR PLACEMENT OF DETECTABLE WARNING.
  - WHEN PLACED ABOVE THE LOWER GRADE BREAK OF A CURB RAMP, DETECTABLE WARNING UNITS SHOULD BE PLACED AS CLOSE TO THE ADJUT AS PRACTICABLE. BOTH FRONT CORNERS OF THE LOWER GRADE BREAK OF A CURB RAMP, DETECTABLE WARNING UNITS SHOULD BE PLACED AS CLOSE TO THE ADJUT AS PRACTICABLE.
  - WHEN RADIUS DWS UNITS ARE PLACED AT THE BACK OF CURB, THE FRONT EDGE OF THE DWS FIELD SHOULD BE AS CLOSE AS POSSIBLE TO THE BACK OF CURB. I.E. THE RADIUS OF THE FRONT OF THE DWS FIELD SHOULD MATCH THE RADIUS OF THE BACK OF CURB AS CLOSELY AS POSSIBLE. THE OUTSIDE CORNERS OF THE DWS FIELD MUST BE LOCATED NO MORE THAN 2 BORDERS FROM THE BACK OF CURB.
  - ON SLOPES OF 5% OR GREATER, THE CORNER OF JOINTS SHALL BE ALIGNED TO BE PERPENDICULAR TO THE RADIUS OF THE LOWER GRADE BREAK ON THE RAMP RUN. THE DETECTABLE WARNING UNITS SHALL BE PLACED AS CLOSE TO THE BACK OF CURB AS POSSIBLE. THE DETECTABLE WARNING UNITS SHALL BE PLACED AS CLOSE TO THE BACK OF CURB AS POSSIBLE. THE DETECTABLE WARNING UNITS SHALL BE PLACED AS CLOSE TO THE BACK OF CURB AS POSSIBLE. THE DETECTABLE WARNING UNITS SHALL BE PLACED AS CLOSE TO THE BACK OF CURB AS POSSIBLE. THE DETECTABLE WARNING UNITS SHALL BE PLACED AS CLOSE TO THE BACK OF CURB AS POSSIBLE.
- THE DETECTABLE WARNING FIELD SHALL BE THE COLOR SPECIFIED IN THE CONTRACT DOCUMENTS OR, IF NOT SPECIFIED, THE COLOR SPECIFIED IN THE STANDARD SPECIFICATIONS. DETECTABLE WARNING SURFACES CONTRAST VISUALLY WITH ADJACENT CEMENT, STREET OR HIGHWAY, OR PEDESTRIAN ACCESS ROUTE SURFACE, EITHER LIGHT-COLOR OR DARK-LIGHT.

NEW YORK  
 Department of  
 Transportation

U.S. DEPARTMENT STANDARD SHEET

PEDESTRIAN FACILITIES  
 SHEET 2 OF 12

APPROVED AUGUST 18, 2001  
 /S/ RICHARD WILSON, P.E.  
 CHIEF ENGINEER

ISSUED UNDER E.T. 21-247  
 608-01

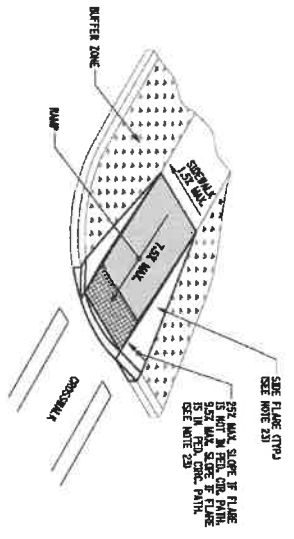

RAMP SIDE OPTION A: FLAMED CONCRETE

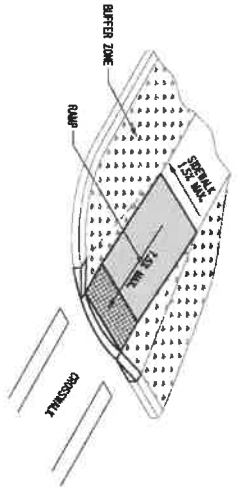

RAMP SIDE OPTION B: GRADED EARTH

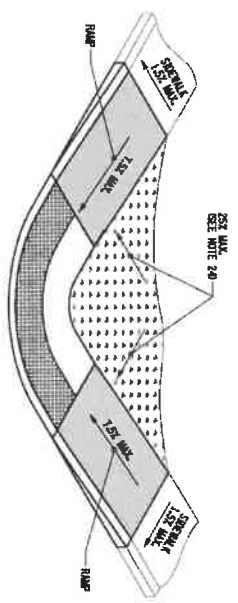

RAMP BACK OPTION A: GRADED EARTH AND TURF

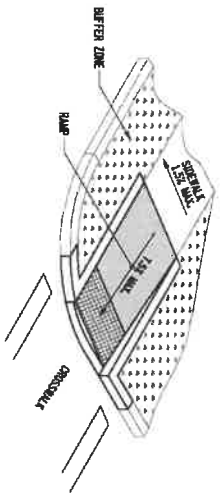

RAMP SIDE OPTION C: RETURN CURB

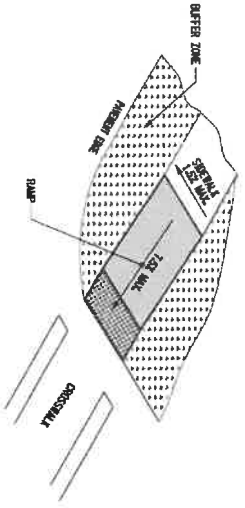

RAMP SIDE OPTION D: UNINCURRED INTERSECTION

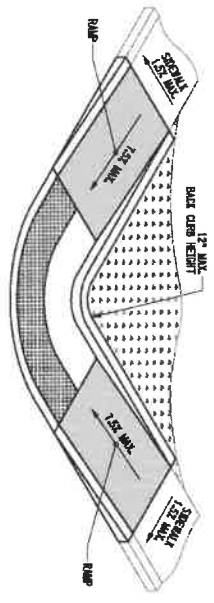

RAMP BACK OPTION B: BACK CURB

RAMP SIDE CONFIGURATIONS

PARALLEL RAMP BACK TREATMENTS

- NOTES
1. ALL NOTES REFERENCED ON THIS SHEET CAN BE FOUND ON STANDARD SHEET 600-01, SHEET 1 OF 12.
  2. A COMPARISON OF RAMP SIDE CONFIGURATIONS CAN BE USED.

 <b>NEW YORK</b> STATE OF NEW YORK U.S. CUSTOMARY STANDARD SHEET	
<b>Department of Transportation</b>	
<b>PEDESTRIAN FACILITIES</b> SHEET 3 OF 121	
APPROVED AUGUST 18, 2021 /s/ RICHARD WITEN, P.E. DEPUTY CHIEF ENGINEER (DESIGN)	ISSUED UNDER E.T. 21-024 600-01

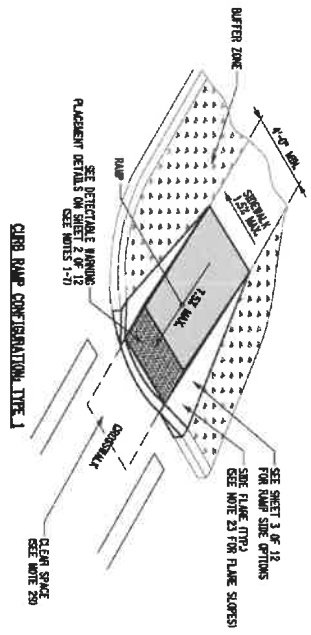

CLEAR RAMP CONFIGURATION TYPE 1

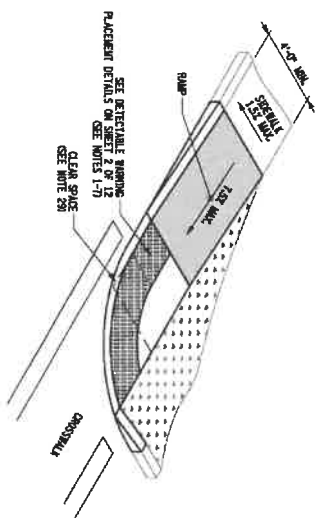

CLEAR RAMP CONFIGURATION TYPE 2

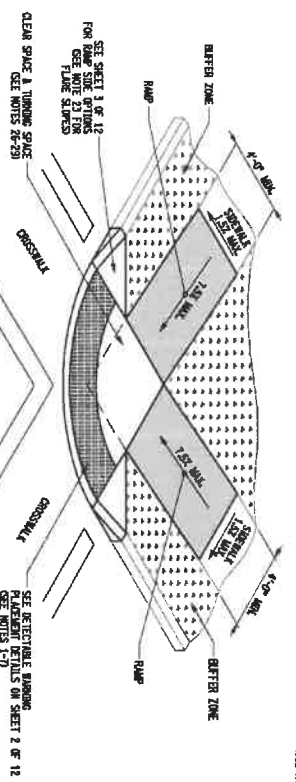

CLEAR RAMP CONFIGURATION TYPE 3

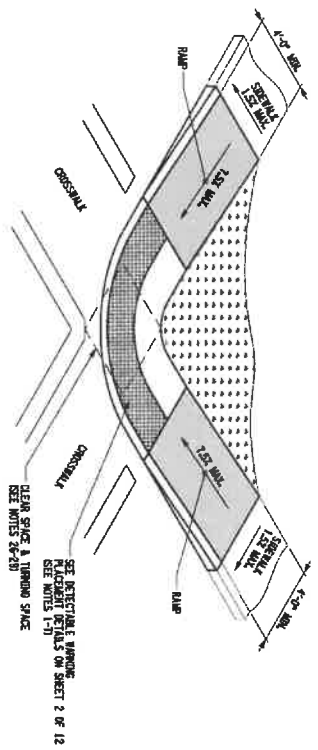

CLEAR RAMP CONFIGURATION TYPE 4

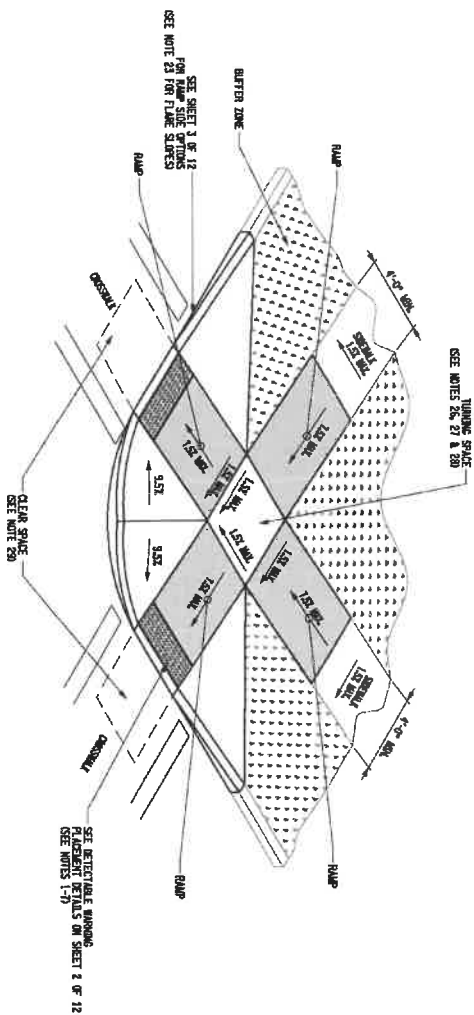

CLEAR RAMP CONFIGURATION TYPE 5

NOTE:  
 ALL NOTES REFERENCED ON THIS SHEET CAN BE FOUND ON STANDARD SHEET 608-01, SHEET 1 OF 12 UNLESS OTHERWISE NOTED

U.S. CUSTOMARY STANDARD SHEET	
<b>Department of Transportation</b>	
<b>PEDESTRIAN FACILITIES</b>	
<b>(SHEET 4 OF 12)</b>	
APPROVED AUGUST 19, 2021 F57 RICHARD WILSON, P.E. SENIOR CHIEF ENGINEER	ISSUED UNDER E.I. 21-024 608-01

NOTE:  
 ALL NOTES REFERENCED ON THIS SHEET CAN BE FOUND ON STANDARD SHEET 608-01, SHEET 1 OF 12 UNLESS OTHERWISE NOTED.

**CRIB RAMP CONFIGURATION TYPE 1**

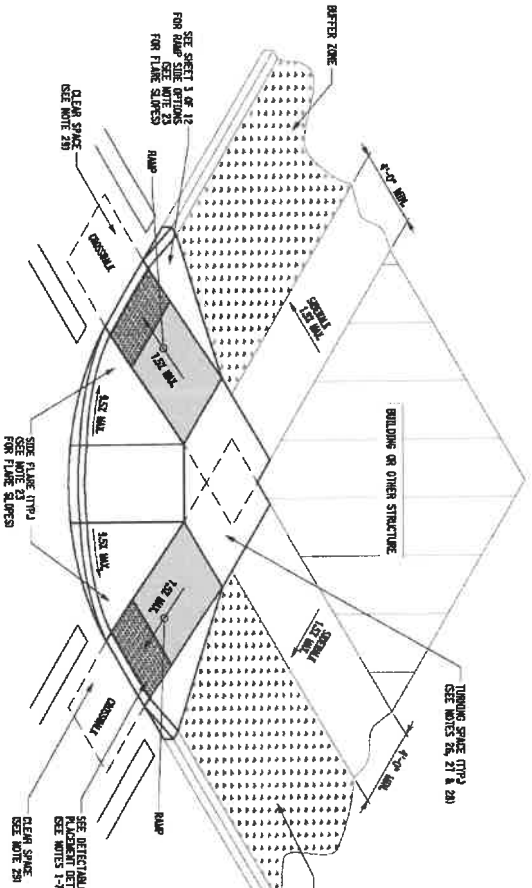

**CRIB RAMP CONFIGURATION TYPE 6**

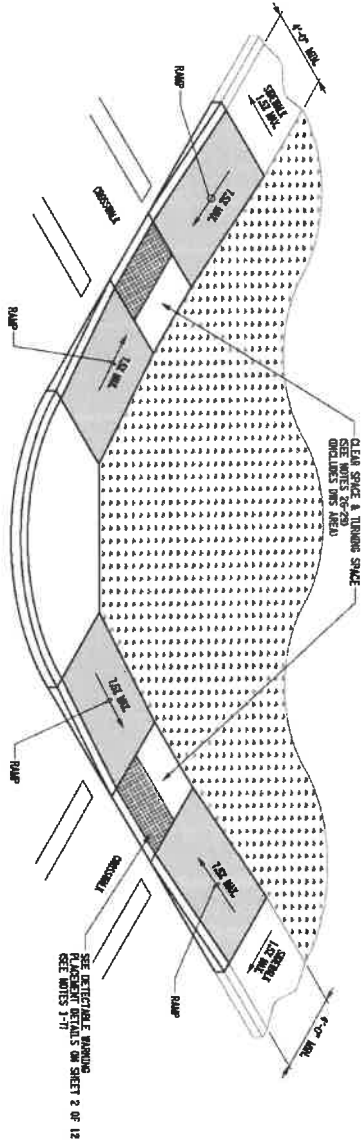

**CRIB RAMP CONFIGURATION TYPE 8**

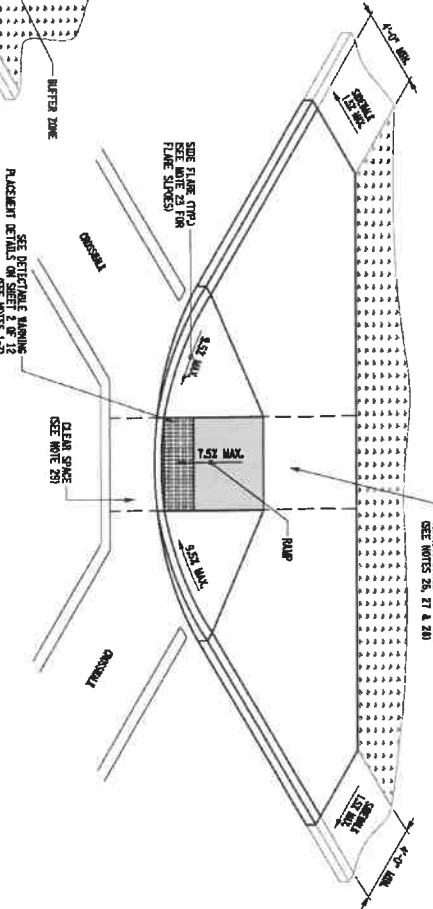

 NEW YORK STATE OF NEW YORK U.S. CUSTOMARY STANDARD SHEET	Department of <b>Transportation</b>
PEDESTRIAN FACILITIES SHEET 5 OF 12	ISSUED UNDER ET 21-074
608-01	608-01



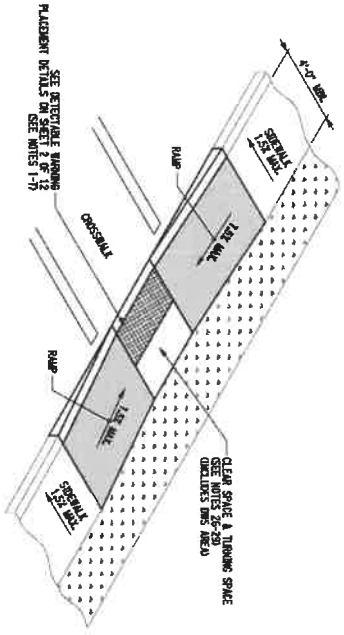

CURB RAMP CONFIGURATION TYPE 9 AND BLOCK CROSSING OR T INTERSECTION

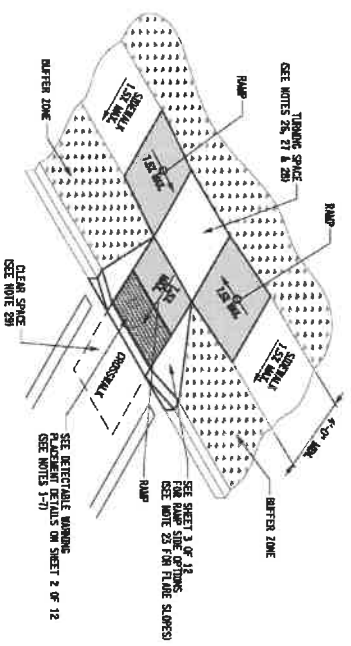

CURB RAMP CONFIGURATION TYPE 10 AND BLOCK CROSSING OR T INTERSECTION

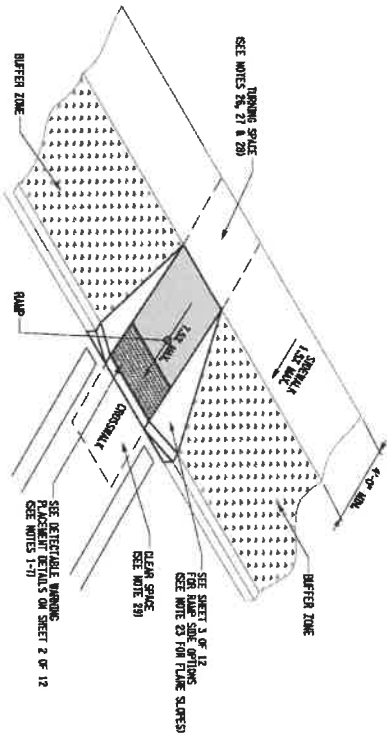

CURB RAMP CONFIGURATION TYPE 11 AND BLOCK CROSSING OR T INTERSECTION

NOTE:  
 ALL NOTES REFERENCED ON THIS SHEET CAN BE FOUND ON STANDARD SHEET 600-01, SHEET 1 OF 12 UNLESS OTHERWISE NOTED.

 <b>NEW YORK</b> DEPARTMENT OF <b>Transportation</b>	
U.S. CUSTOMARY STANDARD SHEET	
<b>PEDESTRIAN FACILITIES</b> (SHEET 6 OF 12)	
APPROVED AUGUST 15, 2021 /S/ RICHARD WILSON, P.E. DEPUTY CHIEF ENGINEER (DESIGN)	ISSUED UNDER ET 21-024 <b>600-01</b>

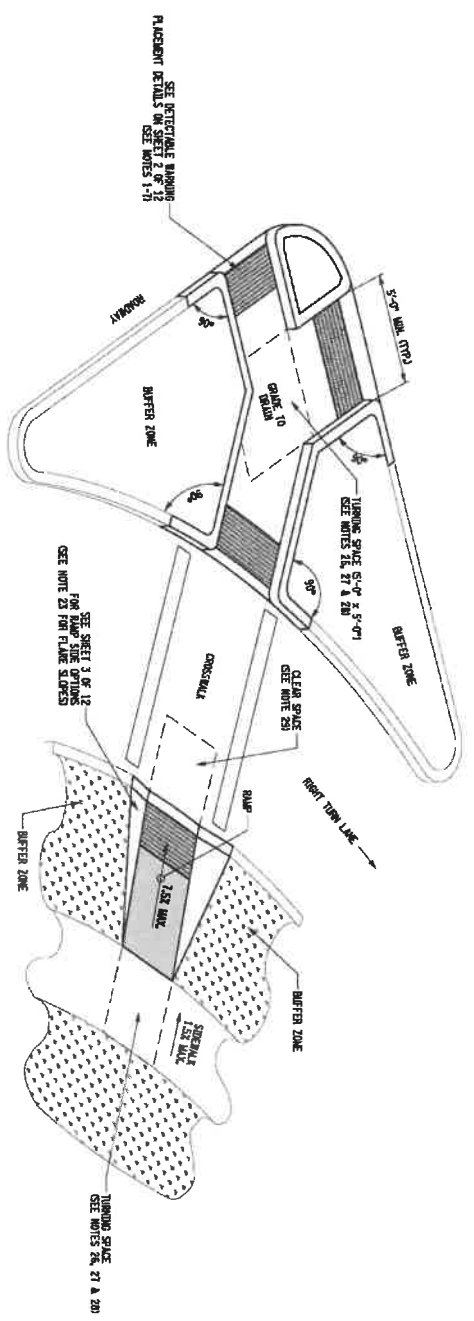

CURB RAMP CONFIGURATION TYPE 12 RIGHT TURN ISLAND CUT THROUGH

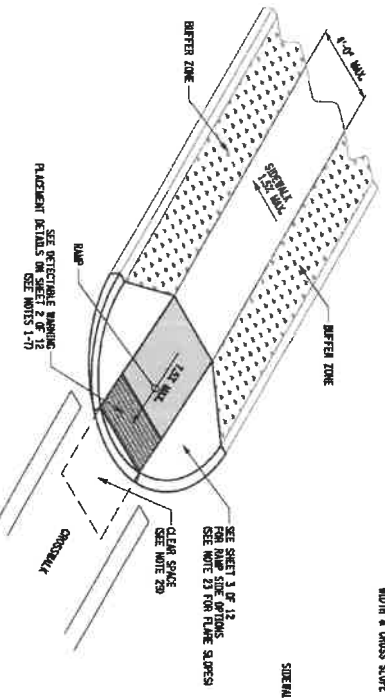

CURB RAMP CONFIGURATION TYPE 13 ACCESS ISLAND CURB RAMP

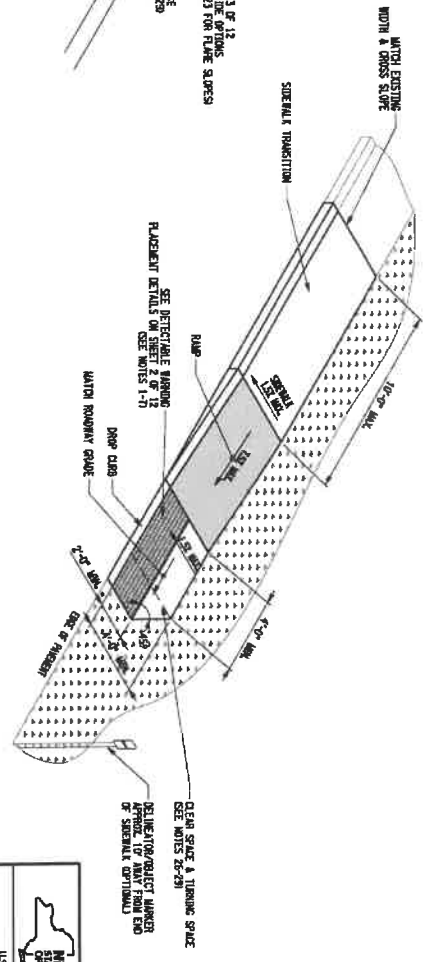

CURB RAMP CONFIGURATION TYPE 14 SHOULDER TO SIDEWALK TRANSITION

NOTES  
 ALL NOTES REFERENCED ON THIS SHEET CAN BE FOUND ON STANDARD SHEET 600-01, SHEET 1 OF 12 UNLESS OTHERWISE NOTED.

 U.S. CUSTOMER STANDARD SHEET	<b>Department of          Transportation</b>
PEDESTRIAN FACILITIES SHEET 7 OF 121	600-01
252 RECORD BUREAU, P.C. RECORDING ENGINEER (DESIGN)	

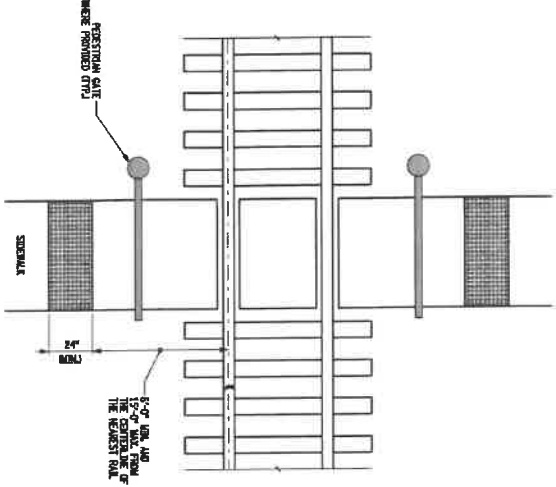

DETECTABLE WARNINGS AT RAILROAD CROSSING

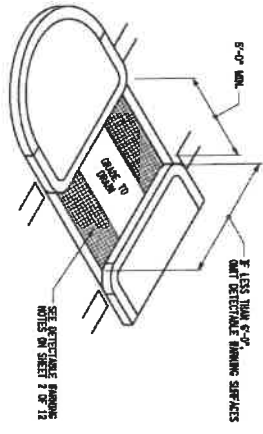

DETECTABLE WARNINGS AT PEDESTRIAN GATE ISLANDS

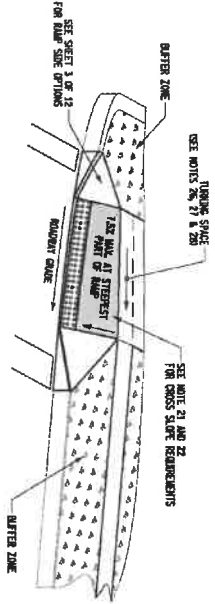

CURB RAMP CROSS SLOPE TRANSITION

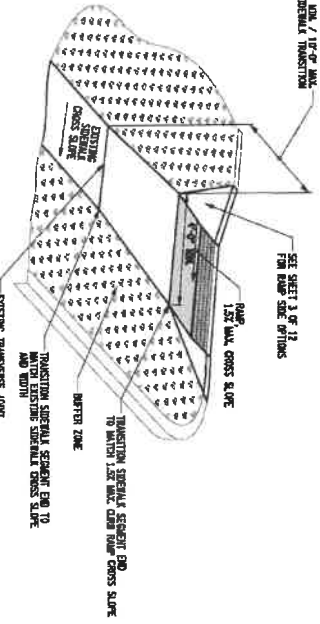

TRANSITION BETWEEN CURB RAMP AND EXISTING SIDEWALK

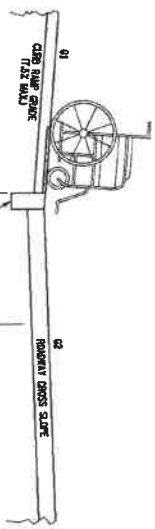

COUNTER SLOPE CONDITION 1

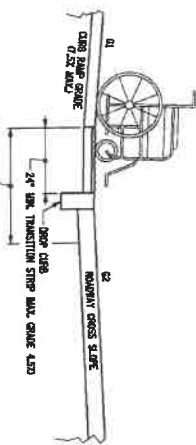

COUNTER SLOPE CONDITION 2

ASSEMBLY DETECTABLE WARNING CROSS SLOPE AND CURB RAMP SHALL BE LESS THAN 1.5%. TRANSITION STRIP REQUIRED MAX. CURB 4.50

COUNTER SLOPE CONDITIONS

NOTES:  
 ALL NOTES REFERENCED ON THIS SHEET CAN BE FOUND ON STANDARD SHEET 608-01, SHEET 1 OF 12 UNLESS OTHERWISE NOTED.

 NEW YORK DEPARTMENT OF TRANSPORTATION	
U.S. CUSTOMARY STANDARD SHEET <b>Department of Transportation</b>	
<b>PEDESTRIAN FACILITIES</b> (SHEET 8 OF 12)	
APPROVED AUGUST 19, 2021 /S/ RICHARD WILDER, P.E. DEPUTY CHIEF ENGINEER (DESIGN)	ISSUED UNDER EI 21-024 <b>608-01</b>

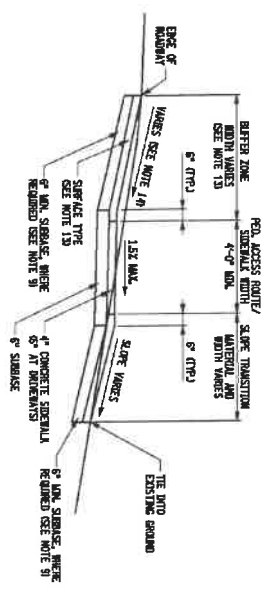

TYPICAL SIDEWALK CROSS SECTION NO CURB WITH BUFFER ZONE IN A FILL SECTION

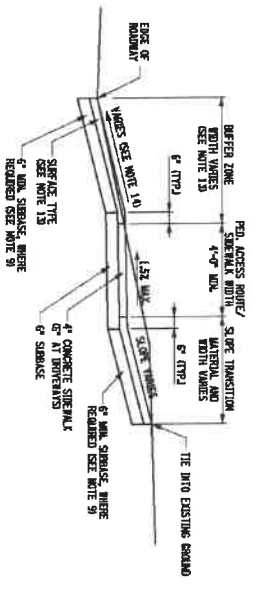

TYPICAL SIDEWALK CROSS SECTION NO CURB WITH BUFFER ZONE IN A CUT SECTION

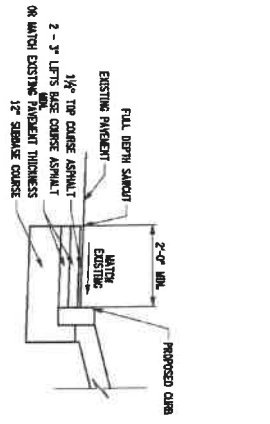

PAVEMENT RECONSTRUCTION OPTION A ASPHALT  
 SEE NOTE 11

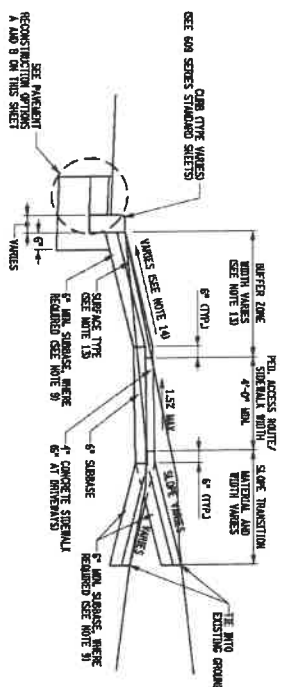

TYPICAL SIDEWALK CROSS SECTION CURBED WITH BUFFER ZONE

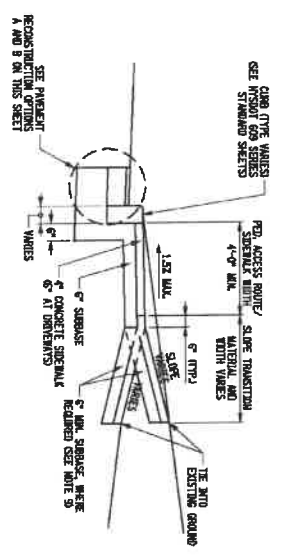

TYPICAL SIDEWALK CROSS SECTION CURBED WITHOUT BUFFER ZONE

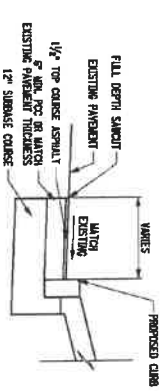

PAVEMENT RECONSTRUCTION OPTION B PORTLAND CEMENT CONCRETE  
 SEE NOTE 11

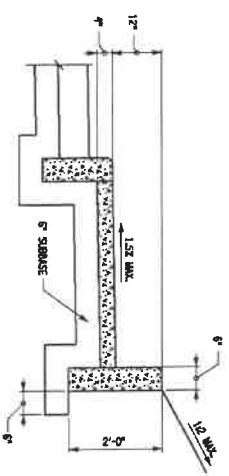

BACK OF CURB DETAIL USE IN CUT SECTIONS WITH LIMITED RIGHT-OF-WAY ON STEEP SLOPES

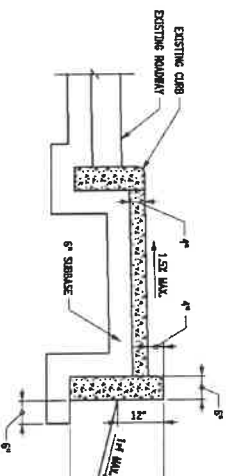

BACK OF CURB DETAIL USE ON FILL SECTIONS WITH LIMITED RIGHT-OF-WAY

NOTE:  
 ALL NOTES REFERENCED ON THIS SHEET CAN BE FOUND ON STANDARD SHEET 601-01, SHEET 1 OF 12.

 NEW YORK DEPARTMENT OF TRANSPORTATION	
U.S. CUSTOMARY STANDARD SHEET <b>Department of Transportation</b>	
<b>PEDESTRIAN FACILITIES</b> (SHEET 9 OF 12)	
APPROVED AUGUST 18, 2021 /S/ RICHARD WILKIN, P.E. DEPUTY CHIEF ENGINEER	ISSUED UNDER E.I. 21-024 600-01
ERRATA 1 EFF. 05/01/2023 ISSUED WITH DS 23-007	

- NOTES:**
1. A HANDRAIL IS A RAIL PROVIDED FOR GRIPPING WITH THE HAND FOR SUPPORT. A RAIL IS A BARBER PLACED TO DISCOURAGE OR PREVENT MOVEMENT IN A CERTAIN DIRECTION. TYPICALLY WHERE THERE IS A NON-SLIP SURFACE IN A CERTAIN DIRECTION, THERE IS A HANDRAIL AND BARBER CAN BE INTEGRATED. SEE NOTE 10. HANDRAILS AND BARBERS CAN BE INTEGRATED.
  2. STAIRS OR RAMP RAIS WITH A ROSE CREATED THAN 6" SHALL HAVE HANDRAILS.
  3. HANDRAILS ARE NOT REQUIRED ON RAMP RAIS OR RAMP OR RESTRICTION REGULATORY NOTES; THEY ARE ONLY REQUIRED ON RAMP RAIS RESTRICTION REGULATORY NOTES.
  4. HANDRAILS, WHERE PROVIDED, SHALL BE PROVIDED ON BOTH SIDES OF THE RAMP OR STAIRWAY.
  5. ALL STEPS ON A RAMP OR STAIRS MUST HAVE LUMINOUS GREEN HEADS AND UNIFORM TREAD DEPTHS. OPEN RISERS ARE PROHIBITED.
  6. A MINIMUM 4" CLEAR WIDTH MUST BE PROVIDED BETWEEN HANDRAILS.
  7. STAIRWAY HANDRAILS SHALL BE LOCATED IN SUCH A MANNER THAT ALL PORTIONS SHALL BE USUALLY ACCESSIBLE.
  8. HANDRAILS SHALL BE GRADED SMOOTH, WITH NO PROTRUSIONS.
  9. EDGE PROTECTION SHALL BE PROVIDED ON BOTH SIDES OF A RAMP AND AT EACH END OF A RAMP OR STAIRWAY. THE PROTECTION SHALL BE 1 1/2" MIN. HIGH AND 1 1/2" MIN. WIDE. THE PROTECTION SHALL BE 1/4" MIN. THICK AND SHALL BE FASTENED TO THE SURFACE WITH AN ANCHOR (TYPE 3) OR A BARBER THAT PREVENTS A SPHERE WITH A DIAMETER OF 4" FROM PASSING BETWEEN THE BOTTOM OF THE SURFACE AND THE OTHER SURFACE. THE PROTECTION SHALL BE 1/4" MIN. THICK AND SHALL BE FASTENED TO THE SURFACE WITH AN ANCHOR (TYPE 3) OR A BARBER THAT PREVENTS A SPHERE WITH A DIAMETER OF 4" FROM PASSING BETWEEN THE BOTTOM OF THE SURFACE AND THE OTHER SURFACE. THE PROTECTION SHALL BE 1/4" MIN. THICK AND SHALL BE FASTENED TO THE SURFACE WITH AN ANCHOR (TYPE 3) OR A BARBER THAT PREVENTS A SPHERE WITH A DIAMETER OF 4" FROM PASSING BETWEEN THE BOTTOM OF THE SURFACE AND THE OTHER SURFACE.
  10. BARBERS FOR GRIPPING PROTECTION ARE REQUIRED FOR OPEN-TREAD STAIRS, RAMP RAIS, AND LAMINAS THAT ARE LOCATED MORE THAN 30" ELEVATION ABOVE THE FLOOR OR GRADE BELOW. ALL RAMP RAIS SHALL BE FASTENED TO THE FLOOR OR GRADE BELOW AT AN INTERVAL WITH THE REQUIREMENTS OF THE NYC BUILDING CODE.

**STANDARD STAIR DIMENSIONS DETAIL**  
 NOT TO SCALE

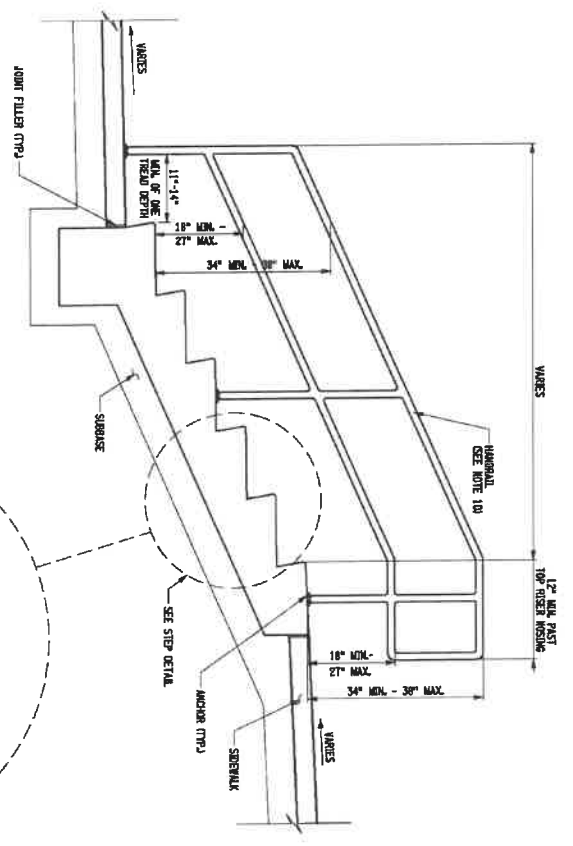

**STANDARD RISER/TREAD DIMENSIONS DETAIL**  
 NOT TO SCALE

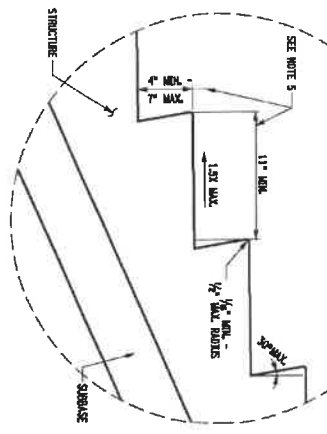

**STANDARD HANDRAIL DIMENSIONS DETAIL FOR RAMPS**  
 NOT TO SCALE

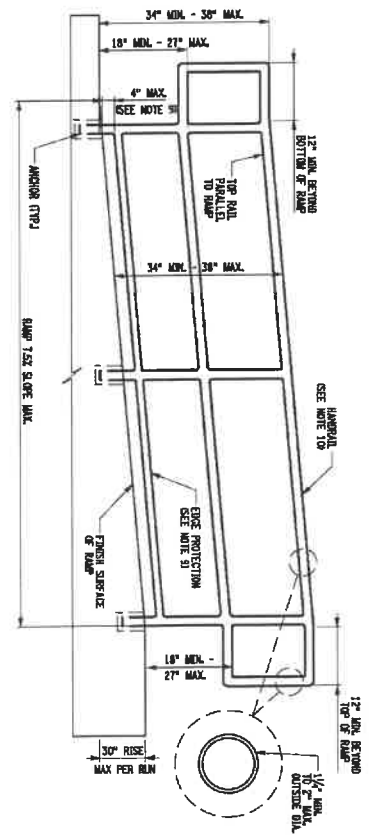

**STANDARD HANDRAIL WALL MOUNTING DIMENSIONS DETAIL**  
 NOT TO SCALE

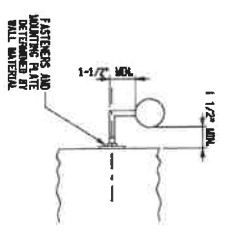

 NEW YORK STATE OF NEW YORK DEPARTMENT OF TRANSPORTATION		U.S. CUSTOMARY STANDARD SHEET Department of Transportation
PEDESTRIAN FACILITIES SHEET 10 OF 121		
APPROVED AUGUST 18, 2021 /S/ RICHARD WILSON, P.E. DEPUTY CHIEF ENGINEER	ISSUED UNDER ET 21-204 608-01	

GENERAL NOTES FOR PEDESTRIAN FACILITIES  
 1. PROGRAM FACILITIES MUST MEET THE VALUES SHOWN ON THE APPROPRIATE TABLE. OR BE JUSTIFIED AS MODIFICATIONS FEATURES USING EXHIBIT 2-15A FROM THE NYSDOT HIGWAY DESIGN MANUAL, CHAPTER 2.

CURB RAMP TO REMAIN ON IA PROJECTS

- ON IA PROJECTS, CURB RAMP SHOULD REMAIN TO MAINTAIN 14' WIDE OR NOT NEED TO BE REPAIRED OR IMPROVED TO MEET DESIGN CRITERIA STANDARDS IF THE CURB RAMP MEETS THE REQUIREMENTS IN THE 1991 ADAAG STANDARDS, SHOWN ON TABLE 1.
- THE MAX. CROSS SLOPE FOR ANY PART OF AN ACCESSIBLE ROUTE IN THE 1991 ADAAG STANDARDS IS 2% UNLESS, CURB RAMP CROSS SLOPES AT INTERSECTIONS WITHIN 10' OF STOP CONTROL CAN WITHIN THE HIGHWAY CROSSING.
- AS DETAIL IN THE "SUPPLEMENT TO THE 2013 POLY/INT JUNCT TECHNICAL ASSISTANCE ON THE TITLE II OF THE ADA REQUIREMENTS TO PROVIDE CURB RAMP CROSS SLOPES, RAMP OR HIGHWAYS ARE ALTERED THROUGH PERIODS OF CONSTRUCTION, DETECTABLE PAVEMENTS ARE REQUIRED ON CURB RAMP BELT OR ALTERED THROUGH THE FOLLOWING PERIODS:  
 JULY 28, 1991 - MAY 12, 1994  
 JULY 28, 2001 - MARCH 15, 2002  
 JULY 28, 2001 - MARCH 15, 2002
- IF A CURB RAMP WAS BUILT ON LAST ALTERED DURING THE PERIODS ABOVE, OR IF THE DATE OF CONSTRUCTION OR LAST ALTERATION CANNOT BE DETERMINED, THE RAMP REQUIRES A DETECTABLE WARNING.
- REQUIREMENTS FOR DETECTABLE WARNING DEVICES AND PLACEMENT ARE TO BE EVALUATED BY CURRENT PROGRAM STANDARDS AS DETAIL ON SHEET 2 OF 12.
- FOR CROSSWALK REQUIREMENTS ON IA PROJECTS, REFER TO TABLE 2, SHEET 12 OF 12, FOR NEW AND RECONSTRUCTION FACILITIES.

NOTES ON NEW AND RECONSTRUCTION PEDESTRIAN FACILITIES

- IF A SURFACE ON OTHER PEDESTRIAN PATH IS WIDER THAN 48" OR ONLY THE MINIMUM CONTINUOUS ACCESSIBLE CLEAR WIDTH OF 48" OR WITH PASSING SPACES AS REQUIRED IS REQUIRED TO MEET THE SURFACE AND SLOPE REQUIREMENTS SHOWN ON TABLE 2, SHEET 12 OF 12.
- REQUIREMENTS FOR HEIGHT AND PROJECTIONS ON CURBS DO NOT APPLY TO HIGHWAY SEGMENTS, HIGHWAY RAMP, OR HIGHWAY BRIDGES WITH BRIDGE OR HIGHWAY BARRIERS.

NOTES ON INSPECTION METHODS MEASUREMENTS

- GRADE RAMPING SLOPES IS TO BE MEASURED AS AN AVERAGE OF AT LEAST 3 DIGITAL LEVEL MEASUREMENTS TAKEN AT EQUAL SPACES ALONG THE GRADE RAMPING SURFACE. THE AVERAGE IS TO BE BASED ON SLOPES LESS THAN OR EQUAL TO THE LIMIT SHOWN IN THE TABLE.
- CROSS SLOPE IS TO BE MEASURED AS AN AVERAGE OF AT LEAST 2 DIGITAL LEVEL MEASUREMENTS, MADE PERPENDICULAR TO THE CENTERLINE DIRECTION OF TRAVEL OF THE SURFACE. MEASUREMENTS SHOULD BE TAKEN AT 9' TO 12' INTERVALS, FOR AT LEAST 2 DIGITAL LEVEL MEASUREMENTS. MEASUREMENTS SHOULD BE TAKEN AT 9' TO 12' INTERVALS, FOR AT LEAST 2 DIGITAL LEVEL MEASUREMENTS. MEASUREMENTS SHOULD BE TAKEN ON SLOPES LESS THAN OR EQUAL TO THE LIMIT SHOWN IN THE TABLE.
- VERT. SLOPE IS TO BE MEASURED BY TAKING GRADE, GROUND SURFACE AND CROSS SLOPE MEASUREMENTS, AS DESCRIBED IN NOTES 9 AND 10. ACCEPTANCE IS BASED ON SLOPES LESS THAN OR EQUAL TO THE LIMIT SHOWN IN THE TABLE.
- WORDS AND OFFSETS ARE TO BE MEASURED AS AN AVERAGE OF AT LEAST TWO TAPE MEASUREMENTS TAKEN PERPENDICULAR TO THE CENTERLINE DIRECTION OF TRAVEL OF THE PEDESTRIAN ROUTE OR PATH. AT OTHER TIMES, MEASUREMENTS SHOULD BE TAKEN PERPENDICULAR TO THE CENTERLINE DIRECTION OF TRAVEL OF THE PEDESTRIAN ROUTE OR PATH. MEASUREMENTS SHOULD BE TAKEN ON SLOPES LESS THAN OR EQUAL TO THE LIMIT SHOWN IN THE TABLE.
- LENGTH IS TO BE MEASURED AS AN AVERAGE OF AT LEAST TWO OF THE MEASUREMENTS TAKEN PERPENDICULAR TO THE CENTERLINE DIRECTION OF TRAVEL OF THE PEDESTRIAN ROUTE OR PATH. MEASUREMENTS SHOULD BE TAKEN ON SLOPES LESS THAN OR EQUAL TO THE LIMIT SHOWN IN THE TABLE.
- WIDTH OF VERTICAL DISTANCE IS TO BE MEASURED AS AN AVERAGE OF AT LEAST TWO OF VERTICAL MEASUREMENTS TAKEN PERPENDICULAR TO THE CENTERLINE DIRECTION OF TRAVEL OF THE PEDESTRIAN ROUTE OR PATH. MEASUREMENTS SHOULD BE TAKEN ON SLOPES LESS THAN OR EQUAL TO THE LIMIT SHOWN IN THE TABLE.
- PERIODIC LIMITATIONS ARE ACCEPTABLE IF THE PERIODIC CANNOT PLACE A SPHERE OF THE GIVEN DIAMETER, DIRECTION OF PEDESTRIAN TRAVEL.
- DIAMETER, PERIMETER, AND ALL OTHER MEASUREMENTS ARE TO BE MEASURED AS DIRECTED BY ITEM SPECIFICATION.
- PEDESTRIAN INSULATION HEIGHT IS TO BE MEASURED AS A SINGLE MEASUREMENT FROM THE CENTER OF THE PEDESTRIAN TO THE POINT DIRECTLY BELOW IT ON THE CLEAR SPACE. ACCEPTANCE IS BASED ON A MEASUREMENT WITHIN THE ACCEPTABLE RANGE OF HEIGHTS SHOWN IN TABLE 2.

TABLE 1 - CRITICAL ELEMENTS FOR THE DESIGN, LAYOUT AND ACCEPTANCE OF PEDESTRIAN FACILITIES.  
 EXISTING CURB RAMP TO REMAIN ON IA PROJECTS  
 (1991 ADAAG STANDARDS)

ELEMENT	LIMITS REQUIRED TO REMAIN EXISTING CURB RAMP (SEE NOTE 1)	INSPECTION METHODS (NOTE 10)
<b>CURB RAMP</b>		
CLEAR WIDTH	36" MIN.	12
FLARE SLOPE FOR RAMP WITHIN A PEDESTRIAN CIRCULATION PATH	10% MAX.	10
FLARE SLOPE FOR RAMP OUTSIDE A PEDESTRIAN CIRCULATION PATH	NO MAX. SLOPE MAY BE CROSS	-
CROSS SLOPE AT INTERSECTION CROSSING WITHIN 10' OF STOP CONTROL	2% MAX.	10
CROSS SLOPE AT INTERSECTION CROSSING WITHIN 10' OF STOP CONTROL BUT FLASHING RED SIGNAL	HIGHWAY GRADE IS MAX. (SEE NOTE 3)	10
GRADE RAMPING SLOPE OF SPACE IS LIMITED	10% FOR 4' RISE	9
GRADE RAMPING SLOPE OF SPACE IS LIMITED	4% x 4' MAX.	12, 13
GRADE RAMPING SLOPE ON WALKING SURFACE	0.5% MAX.	15
VERTICAL CHANGES	0.5% MAX. WITH 12" MAX. RISE BETWEEN CDS AND 0.5" RISE	14

NEW YORK  
 DEPARTMENT OF  
 TRANSPORTATION  
 U.S. CUSTOMARY STANDARD SHEET

PEDESTRIAN FACILITIES  
 SHEET 11 OF 121

APPROVED: AUGUST 15, 2021  
 FOR: RICHARD WILDER, P.E.  
 DESIGN CHIEF ENGINEER

ISSUED UNDER EET 21-024  
 608-01







**TABLE 1**  
**RECOMMENDED DRIVEWAY WIDTH**

DRIVEWAY CLASSIFICATION	RECOMMENDED RANGE OF WIDTHS (FT) WITH 30 FT. OF TRAVEL WAY FOR RADIUS OF CURVE 40 FT. OR LESS	RECOMMENDED RANGE OF WIDTHS (FT) WITH 30 FT. OF TRAVEL WAY FOR RADIUS OF CURVE 50 FT. OR GREATER
RESIDENTIAL LESS THAN 50 FT. IN LENGTH	9 TO 12	10 TO 24
RESIDENTIAL GREATER THAN 50 FT. IN LENGTH	9 TO 12	10 TO 14
MINOR COMMERCIAL	22 TO 30	28 TO 35
MAJOR COMMERCIAL, TRAVEL OR ONE-WAY DRIVEWAY	12 TO 24	12 TO 24
MULTI-LANE DRIVEWAY	12 TO 18 EACH LANE	14 TO 18 EACH LANE

**TABLE 2**  
**MAXIMUM DRIVEWAY SLOPE**

DRIVEWAY CLASSIFICATION	MAXIMUM SLOPE (%)
RESIDENTIAL	12%
URBAN	8%

**TABLE 3**  
**DRIVEWAY MATERIALS AND THICKNESS**

PROPOSED OR EXISTING DRIVEWAY MATERIAL	MINIMUM DRIVEWAY PAVEMENT LENGTH (FT.)		MATERIAL	MINIMUM TRAVELWAY LENGTH (FT.)	
	THICKNESS FOR RESIDENTIAL ONLY	THICKNESS FOR MAJOR COMMERCIAL ONLY		THICKNESS FOR RESIDENTIAL ONLY	THICKNESS FOR MAJOR COMMERCIAL ONLY
DIRTY GRAVEL OR GRAVEL	3	4	STONE ESTIMATE AS NECESSARY	5	9
	6	8		8	11
STONE	3	4	STONE ESTIMATE AS NECESSARY	5	9
	6	8		8	11
HMA	1/2	1/2	NOT APPLICABLE - ALL WORK ON AN EXISTING PAVED DRIVEWAY IS WITHIN THE DRIVEWAY PAVEMENT LENGTH		
	AS NECESSARY	AS NECESSARY			
HMA	3	4 (SEE NOTE #)	NOT APPLICABLE - ALL WORK ON AN EXISTING PAVED DRIVEWAY IS WITHIN THE DRIVEWAY PAVEMENT LENGTH		
	AS NECESSARY	4 (SEE NOTE #)			
RECONSTRUCTION	6	6 (SEE NOTE 10)	NOT APPLICABLE - ALL WORK ON AN EXISTING PAVED DRIVEWAY IS WITHIN THE DRIVEWAY PAVEMENT LENGTH		
	6	6 (SEE NOTE 10)			
PCC	6	6 (SEE NOTE 10)	NOT APPLICABLE - ALL WORK ON AN EXISTING PAVED DRIVEWAY IS WITHIN THE DRIVEWAY PAVEMENT LENGTH		
	6	6 (SEE NOTE 10)			

**TABLE 4**  
**DRIVEWAY ENTRANCE TYPE SELECTION**

DRIVEWAY ENTRANCE TYPE	DRIVEWAY CLASSIFICATION (NOTE 1)	CORNER RADIUS	TRAVEL LANE WIDTH	CHINA	SIDEWALK	DESIGN SPEED	RECOMMENDED USE
TYPE 1	RESIDENTIAL OR MAJOR COMMERCIAL	60"	AVG	USE WITH OR WITHOUT CURB	USE WITH SIDEWALK	AVG SPEED	RECOMMENDED FOR ALL MAJOR COMMERCIAL WITH CURB
TYPE 2	MINOR COMMERCIAL ONLY	60" TO 70"	AVG	USE WITH CURB	USE WITH OR WITHOUT SIDEWALK	AVG SPEED	RECOMMENDED ONLY FOR MAJOR COMMERCIAL WITH CURB
TYPE 3	RESIDENTIAL OR MAJOR COMMERCIAL	60" TO 100"	16' OR GREATER OR GREATER THAN 16' 6"	USE ONLY WITH CURB	USE ONLY WITH SIDEWALK	ONLY LOW SPEED (25 MPH OR LESS)	ALTERNATIVE ENTRANCE TYPE (TYPICALLY FOR URBAN AREA USE)
TYPE 4	RESIDENTIAL OR MAJOR COMMERCIAL	100"	16' OR GREATER OR GREATER THAN 16' 6"	USE ONLY WITH CURB	USE ONLY WITH SIDEWALK	ONLY LOW SPEED (25 MPH OR LESS)	ALTERNATIVE ENTRANCE TYPE (TYPICALLY FOR URBAN AREA USE)

**TABLE 5**  
**MINIMUM LENGTH OF VERTICAL CURVE, L<sub>v</sub>, FOR CHANGE IN GRADE IN DRIVEWAY PROFILE**

CHANGES IN GRADE	CREST, L <sub>v</sub> (FT)	SAG, L <sub>v</sub> (FT)
4-8%	5	5
6-8%	5	7
8-10%	6	8
10-12%	6	8
12-14%	7	9
14-16%	7	9
16-18%	8	10
18-20%	8	10

LENGTH OF VERTICAL CURVE BASED ON 30' CORNER RADIUS AND THE MAJOR PASSENGER VEHICLE AND SMOKE UNIT TRUCK CLEARANCES.

**NOTE:**  
 ALL GENERAL NOTES AND ABERRATIONS REFERENCED ON THIS SHEET CAN BE FOUND ON STANDARD SHEET 608-03, SHEET 1 OF 9.

TABLE 4 ONLY APPLIES TO RESIDENTIAL AND MAJOR COMMERCIAL DRIVEWAYS. FOR OTHER DRIVEWAY CLASSIFICATIONS MAJOR COMMERCIAL, FIELD ENTRANCE, ETC. REFER TO THE PROPOSED DESIGN MANUAL CHAPTER 2, PARAGRAPH 2A, TABLE 2A, AND SIDEWALKS FOR THE DESIGN OF ENTRANCES TO STATE HIGHWAYS.

NEW YORK  
 DEPARTMENT OF  
 TRANSPORTATION  
 U.S. CUSTOMARY STANDARD SHEET

**RESIDENTIAL AND MAJOR COMMERCIAL DRIVEWAYS**  
 (SHEET 2 OF 9)

APPROVED MARCH 07, 2016  
 /S/ ROBERT B. LEE, P.E.  
 DEPUTY CHIEF ENGINEER

ISSUED UNDER E3 16-012  
 608-03



TABLE 9  
DRIVEWAY OPENING "IN" FT. VALUES FOR RADIUS METHOD  
RESIDENTIAL DRIVEWAYS < 13' WIDE (R-167)

CORNER ANGLE	DRIVEWAY OFFSET FROM INSIDE EDGE OF TRAVEL LANE OR OFFSET FROM OUTSIDE EDGE OF A 12' TRAVEL LANE											
	12'	13'	14'	15'	16'	17'	18'	19'	20'	21'	22'	23'
60°	22.3	19.7	17.4	15.7	14.1	12.5	11.2	9.8	8.9	8.3	7.8	6.9
65°	18.7	16.1	14.1	12.5	11.2	10.2	9.2	8.2	7.6	7.2	6.8	6.2
70°	17.7	15.1	13.1	11.5	10.2	9.2	8.2	7.6	7.2	6.8	6.4	6.0
75°	15.7	13.1	11.5	9.8	8.5	7.2	6.2	5.2	4.8	4.5	4.3	4.1
80°	14.1	11.5	9.8	8.5	7.2	6.2	5.2	4.5	4.3	4.1	3.9	3.7
85°	12.5	10.2	8.5	6.9	5.9	4.9	4.3	3.9	3.6	3.4	3.2	3.0
90°	10.8	8.9	7.2	5.9	4.9	4.3	3.9	3.6	3.4	3.2	3.0	2.8
95°	9.5	7.5	5.9	4.9	4.3	3.9	3.6	3.4	3.2	3.0	2.8	2.6
100°	8.5	6.8	4.9	3.9	3.0	2.3	1.8	1.3	1.0	0.7	0.3	0.0
105°	7.2	5.8	4.3	3.0	2.3	1.8	1.3	0.7	0.3	0.0	0.0	0.0
110°	6.6	4.8	3.3	2.3	1.8	1.0	0.7	0.3	0.0	0.0	0.0	0.0
115°	5.6	3.8	2.5	1.8	1.0	0.7	0.3	0.0	0.0	0.0	0.0	0.0
120°	4.6	3.0	2.0	1.3	0.7	0.3	0.0	0.0	0.0	0.0	0.0	0.0

TABLE 10  
DRIVEWAY OPENING "IN" FT. VALUES FOR RADIUS METHOD  
RESIDENTIAL DRIVEWAYS > 13' WIDE (R-167)

CORNER ANGLE	DRIVEWAY OFFSET FROM INSIDE EDGE OF TRAVEL LANE OR OFFSET FROM OUTSIDE EDGE OF A 12' TRAVEL LANE											
	12'	13'	14'	15'	16'	17'	18'	19'	20'	21'	22'	23'
60°	17.4	14.8	12.5	11.2	9.8	8.5	7.2	6.2	5.2	4.6	3.6	2.6
65°	15.4	12.8	11.2	9.5	8.2	6.9	5.9	4.9	4.3	3.3	2.6	2.0
70°	13.5	11.2	9.5	8.2	6.9	5.9	4.9	4.3	3.3	2.6	2.0	1.3
75°	12.1	9.8	8.2	6.9	5.9	4.6	3.6	3.0	2.3	2.0	1.3	1.0
80°	10.8	8.5	6.8	5.9	4.6	3.6	3.0	2.3	2.0	1.3	1.0	0.7
85°	9.2	7.2	5.9	4.6	3.6	3.0	2.3	1.8	1.3	1.0	0.7	0.3
90°	8.2	6.2	4.9	3.9	3.0	2.3	1.8	1.3	1.0	0.7	0.3	0.0
95°	7.2	5.2	4.3	3.3	2.3	1.8	1.3	0.7	0.3	0.0	0.0	0.0
100°	6.2	4.6	3.3	2.3	1.8	1.3	0.7	0.3	0.0	0.0	0.0	0.0
105°	5.6	3.9	2.8	2.0	1.3	0.7	0.3	0.0	0.0	0.0	0.0	0.0
110°	4.6	3.3	2.0	1.3	1.0	0.3	0.0	0.0	0.0	0.0	0.0	0.0
115°	3.9	2.5	1.6	1.0	0.7	0.3	0.0	0.0	0.0	0.0	0.0	0.0
120°	3.3	2.0	1.0	0.7	0.3	0.0	0.0	0.0	0.0	0.0	0.0	0.0

TABLE 11  
DRIVEWAY OPENING "IN" FT. VALUES FOR RADIUS METHOD  
MINOR COMMERCIAL DRIVEWAYS (R-377)

CORNER ANGLE	DRIVEWAY OFFSET FROM INSIDE EDGE OF TRAVEL LANE OR OFFSET FROM OUTSIDE EDGE OF A 12' TRAVEL LANE											
	12'	13'	14'	15'	16'	17'	18'	19'	20'	21'	22'	23'
60°	46.2	44.6	41.2	39.0	36.7	34.6	32.8	31.2	29.5	27.9	26.2	24.3
65°	43.3	39.4	36.1	34.1	32.2	30.2	28.2	26.5	24.8	23.2	21.6	20.3
70°	38.7	35.1	32.2	29.9	27.9	25.9	24.3	22.5	21.3	20.0	18.7	17.7
75°	34.8	31.2	28.5	26.2	24.3	22.5	21.0	19.4	17.7	16.4	15.1	14.1
80°	31.2	27.5	24.9	23.0	21.0	19.4	17.7	16.4	15.1	13.8	12.6	11.5
85°	27.9	24.5	22.0	20.0	18.0	16.7	15.1	13.8	12.6	11.5	10.5	9.5
90°	24.9	21.7	19.4	17.4	15.1	13.8	12.6	11.5	10.5	9.5	8.5	7.5
95°	22.3	19.0	16.7	14.8	12.8	11.2	10.2	9.2	8.2	7.5	6.8	6.2
100°	19.7	16.7	14.4	12.8	11.2	10.2	9.2	8.2	7.5	6.8	6.2	5.6
105°	17.7	14.8	12.5	10.8	9.2	8.2	7.5	6.8	6.2	5.6	5.2	4.8
110°	15.4	12.5	10.5	8.9	7.5	6.8	6.2	5.6	5.2	4.8	4.3	3.9
115°	13.5	10.8	8.9	7.2	5.9	4.9	4.3	3.9	3.6	3.3	2.9	2.6
120°	11.5	8.9	7.2	5.6	4.3	3.6	3.3	2.9	2.6	2.3	1.9	1.6

TABLE 12  
DRIVEWAY OPENING "IN" FT. VALUES FOR TAPER METHOD  
RESIDENTIAL DRIVEWAYS

CORNER ANGLE	DRIVEWAY OFFSET FROM INSIDE EDGE OF TRAVEL LANE OR OFFSET FROM OUTSIDE EDGE OF A 12' TRAVEL LANE											
	12'	13'	14'	15'	16'	17'	18'	19'	20'	21'	22'	23'
60°	11.2	10.5	9.9	9.2	8.5	7.9	7.2	6.6	6.3	5.2	4.6	4.6
65°	9.8	9.2	8.5	7.9	7.2	6.3	6.2	5.6	5.2	4.6	4.3	3.9
70°	8.2	7.9	7.2	6.9	6.3	5.9	5.2	4.9	4.3	3.9	3.9	3.0
75°	6.9	6.5	6.2	5.9	5.2	4.9	4.3	4.3	3.5	3.5	3.0	3.0
80°	5.6	5.2	4.9	4.6	4.3	4.3	3.5	3.5	3.0	2.6	2.6	2.3

TABLE 13  
DRIVEWAY OPENING "IN" FT. VALUES FOR TAPER METHOD  
MINOR COMMERCIAL DRIVEWAYS

CORNER ANGLE	DRIVEWAY OFFSET FROM INSIDE EDGE OF TRAVEL LANE OR OFFSET FROM OUTSIDE EDGE OF A 12' TRAVEL LANE											
	12'	13'	14'	15'	16'	17'	18'	19'	20'	21'	22'	23'
60°	74.9	74.3	74.3	72.8	71.7	71.0	70.0	69.4	68.4	67.4	66.7	66.0
65°	62.3	61.4	61.0	60.0	59.1	58.1	57.0	56.0	55.1	54.4	53.7	53.4
70°	50.7	49.7	49.4	48.4	47.4	46.4	45.4	44.4	43.4	42.4	41.4	41.0
75°	44.8	44.1	43.4	42.4	41.4	40.4	39.4	38.4	37.4	36.4	35.4	34.4

TABLE 14  
DRIVEWAY OPENING BOTH "IN" AND "OUT" CALCULATION

CORNER ANGLE	60°/150°	65°/155°	70°/160°	75°/165°	80°/170°	85°/175°	90°
SECT FACTOR "IN"	1.15	1.10	1.07	1.04	1.02	1.01	1.00

NOTES SPECIFIC TO TABLES 9 THROUGH 14:  
TABLES 9 THROUGH 14 ARE FOR PRELIMINARY CONCEPT LAYOUT OF THE DRIVEWAY OPENING WORKS. USE THE LAYOUT METHOD DESCRIBED ON SHEET 3 FOR FINAL DRIVEWAY LAYOUT THROUGH THE DRIVEWAY OPENING LIMITS SHOULD MATCH BETWEEN THE PRELIMINARY AND FINAL LAYOUT TECHNIQUES. THE DRIVEWAY OPENING WIDTH VARIES DEPENDING ON THE DRIVEWAY ENTRANCE DESIGN METHOD USED (RADIUS OR TAPER). THE TAPER METHOD GENERALLY WILL PROVIDE A WIDER DRIVEWAY WIDTH.  
"IN" REFERS TO EITHER "IN" OR "OUT".  
SEE GENERAL NOTE 15.

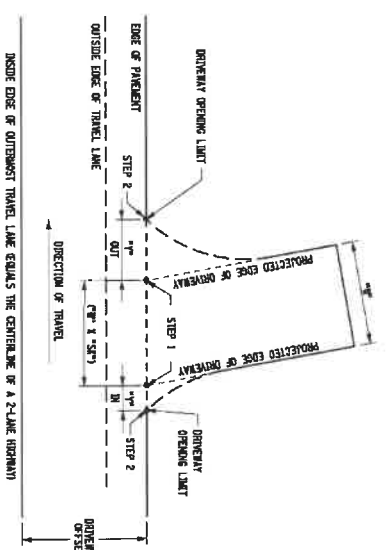

ALTHOUGH THE DETAIL ONLY SHOWS A RADIUS ENTRANCE TYPE, THE DETAIL APPLIES TO BOTH RADIUS AND TAPER METHODS OF LAYOUT. FOR THE VALUES OF "IN" REFER TO TABLES 9 THROUGH 13. FOR THE VALUE OF "SECT" REFER TO TABLE 14.

APPROVED: MARCH 07, 2015  
ISSUED UNDER: EB 15-012

608-03

RESIDENTIAL AND MINOR COMMERCIAL DRIVEWAYS  
SHEET 4 OF 91

NEW YORK  
STATE  
DEPARTMENT OF  
TRANSPORTATION

U.S. CUSTOMARY STANDARD SHEET

Department of  
Transportation

7/S/ RICHARD W. LEE, P.E.  
DEPUTY CHIEF ENGINEER



NOTE:  
 ALL GENERAL NOTES AND ABBREVIATIONS REFERENCED ON THIS SHEET  
 CAN BE FOUND ON STANDARD SHEET 608-03 SHEET 1 OF 3.

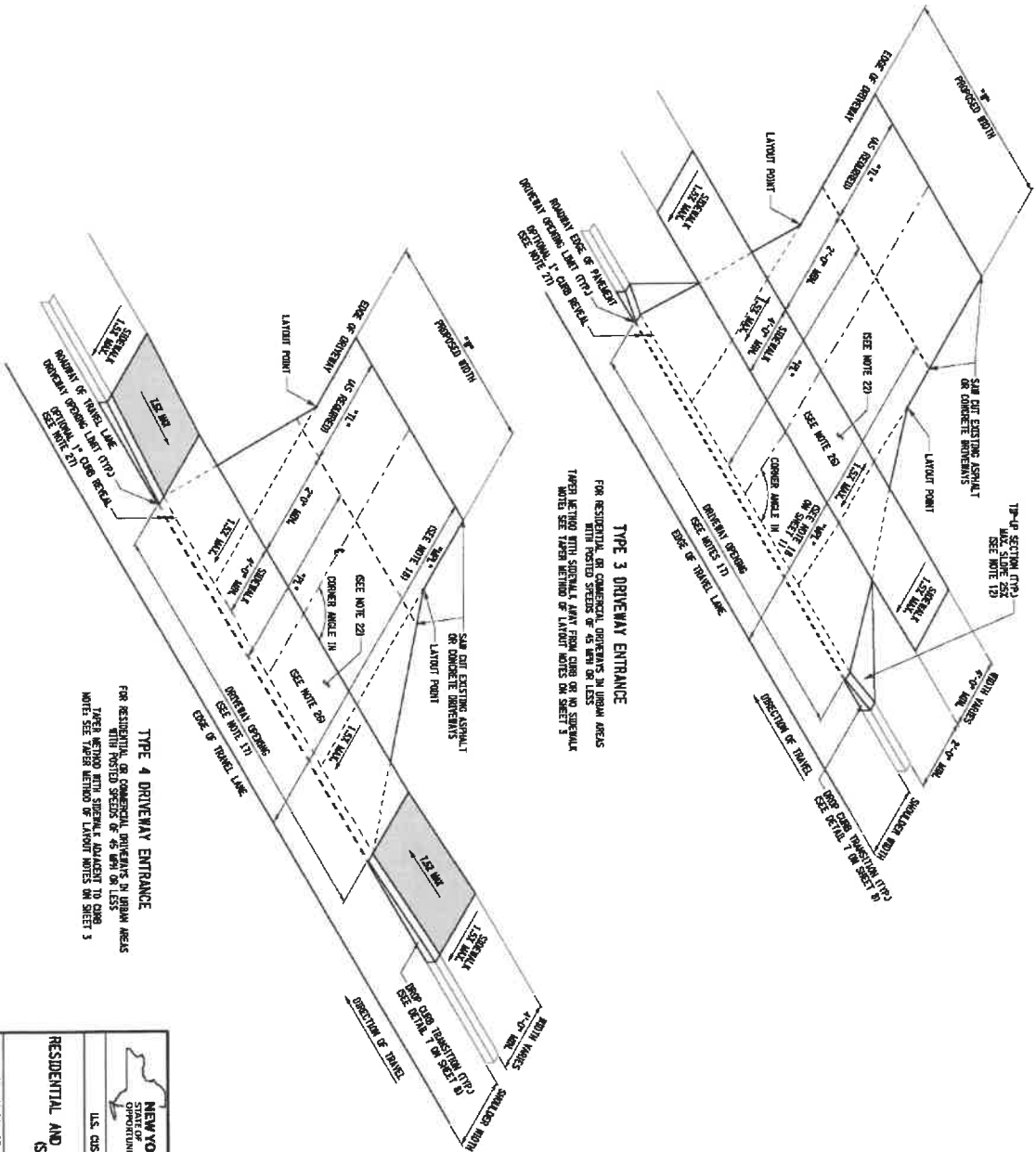

TYPE 3 DRIVEWAY ENTRANCE  
 FOR RESIDENTIAL OR COMMERCIAL DRIVEWAYS IN URBAN AREAS  
 WITH POSTED SPEEDS OF 45 MPH OR LESS  
 THESE NOTES APPLY TO DRIVEWAYS WITH POSTED SPEEDS OF 45 MPH OR LESS  
 UNLESS OTHERWISE NOTED ON SHEET 3

TYPE 4 DRIVEWAY ENTRANCE  
 FOR RESIDENTIAL OR COMMERCIAL DRIVEWAYS IN URBAN AREAS  
 WITH POSTED SPEEDS OF 45 MPH OR LESS  
 THESE NOTES APPLY TO DRIVEWAYS WITH POSTED SPEEDS OF 45 MPH OR LESS  
 UNLESS OTHERWISE NOTED ON SHEET 3

 NEW YORK STATE OF NEW YORK DEPARTMENT OF TRANSPORTATION	U.S. CUSTOMER STANDARD SHEET
	RESIDENTIAL AND URBAN COMMERCIAL DRIVEWAYS SHEET 6 OF 91
APPROVED MARCH 07, 2015 /s/ RICHARD N. LEE, P.E. DEPUTY CHIEF ENGINEER	ISSUED UNDER EB 16-012 608-03

NOTE:  
 ALL GENERAL NOTES AND ABBREVIATIONS REFERENCED ON THIS SHEET  
 CAN BE FOUND ON STANDARD SHEET 608-03, SHEET 1 OF 3.

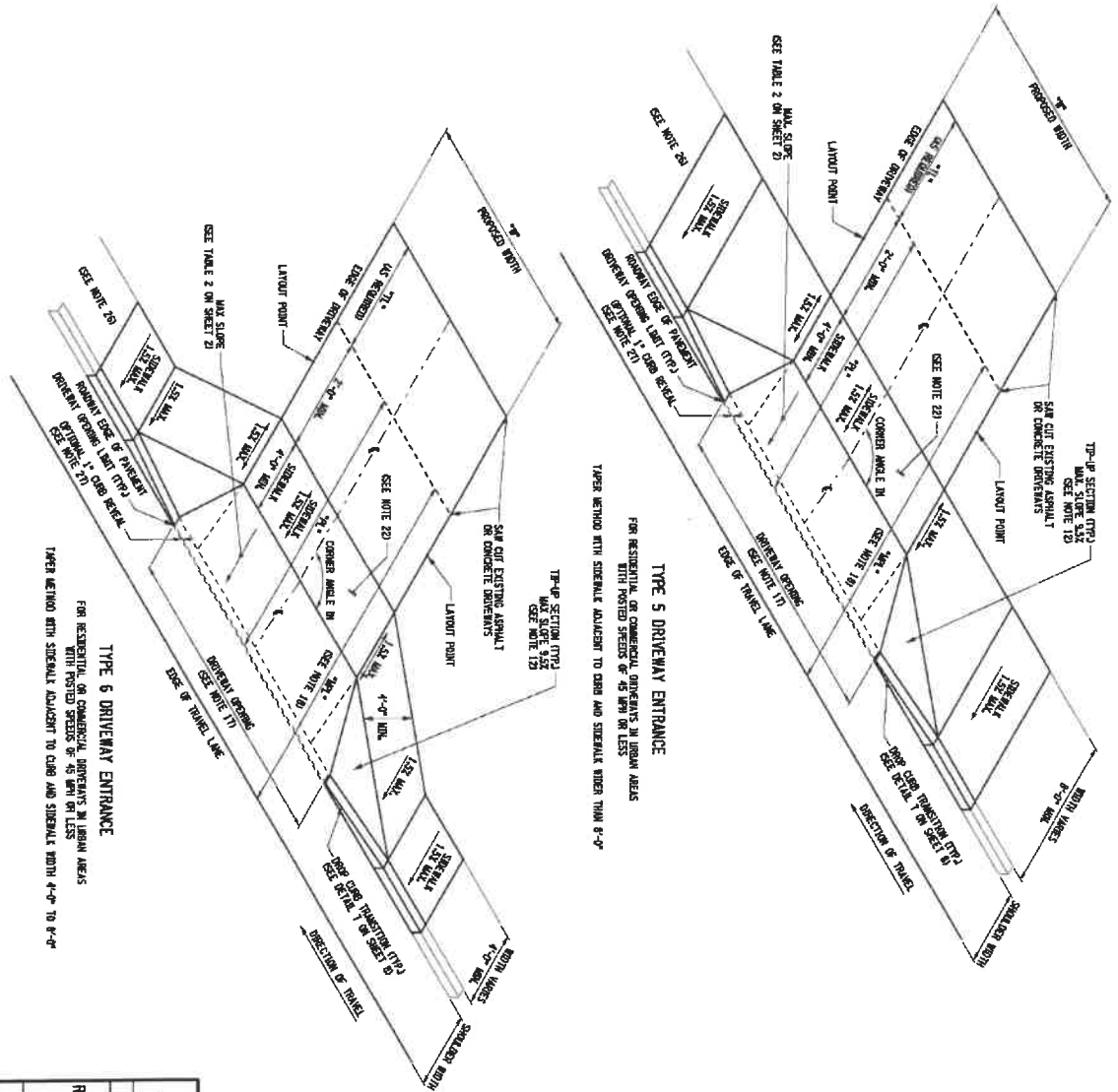

TYPE 5 DRIVEWAY ENTRANCE  
 FOR RESIDENTIAL OR COMMERCIAL DRIVEWAYS IN URBAN AREAS  
 WITH POSTED SPEEDS OF 45 MPH OR LESS  
 TYPED METHOD WITH SIDEWALK ADJACENT TO CURB AND SIDEWALK WIDER THAN 6'-0"

TYPE 6 DRIVEWAY ENTRANCE  
 FOR RESIDENTIAL OR COMMERCIAL DRIVEWAYS IN URBAN AREAS  
 WITH POSTED SPEEDS OF 45 MPH OR LESS  
 TYPED METHOD WITH SIDEWALK ADJACENT TO CURB AND SIDEWALK WIDER THAN 4'-0" TO 6'-0"

 NEW YORK GOVERNMENT U.S. DEPARTMENT OF TRANSPORTATION	
<b>Department of Transportation</b>	
<b>RESIDENTIAL AND MINOR COMMERCIAL DRIVEWAYS</b> SHEET 7 OF 91	
APPROVED MARCH 07, 2016 AS/ ROBERT B. LEE, P.E. DEPUTY CHIEF ENGINEER DESIGN	ISSUED UNDER EB 16-012 608-03

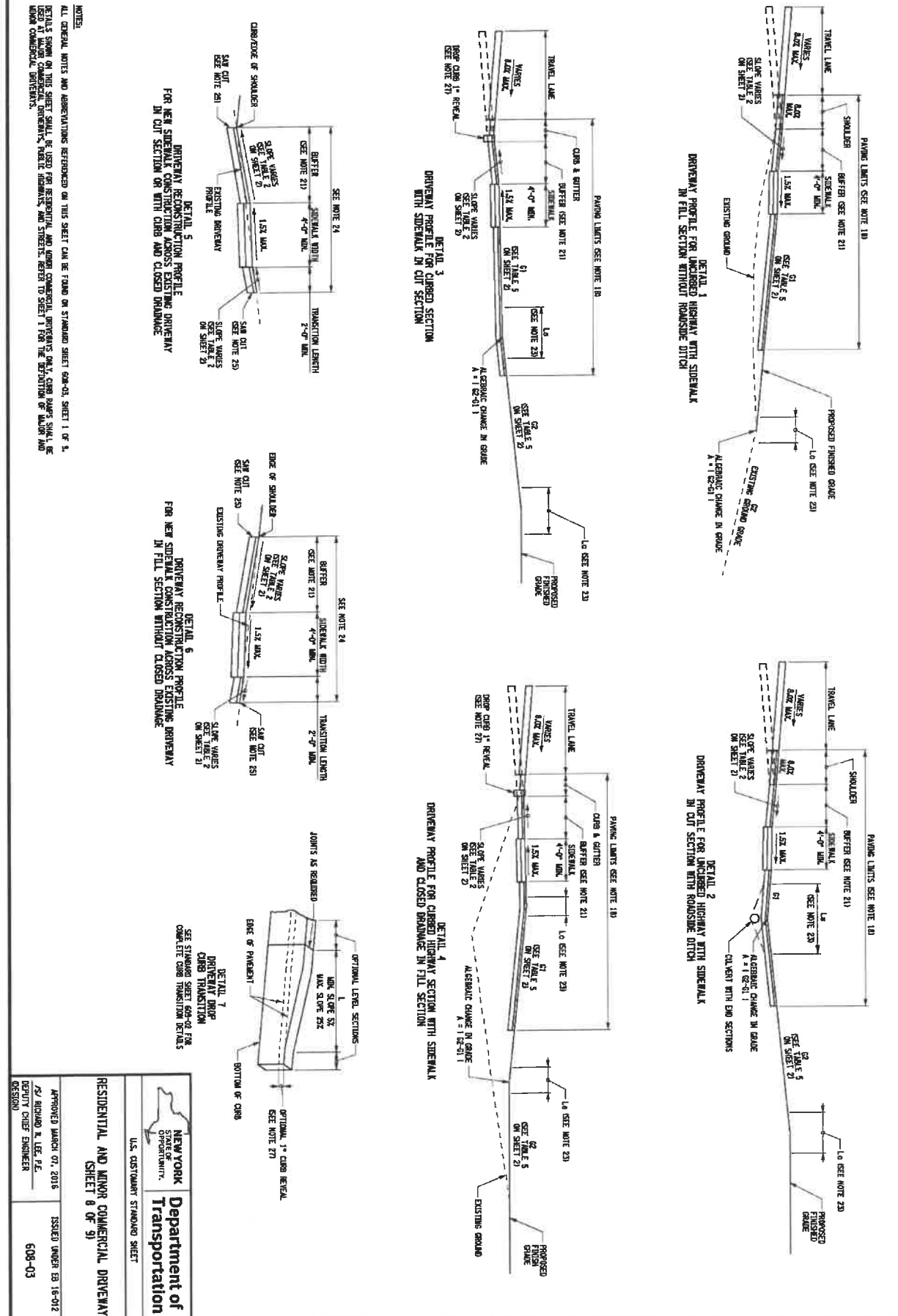

RESIDENTIAL AND MINOR COMMERCIAL DRIVEWAYS  
 SHEET 8 OF 91

NEW YORK  
 DEPARTMENT OF  
 TRANSPORTATION  
 U.S. CUSTOMER STANDARD SHEET

APPROVED MARCH 07, 2016  
 /s/ MICHAEL A. LEE, P.E.  
 DEPUTY CHIEF ENGINEER

ISSUED UNDER E9 16-012  
 609-03

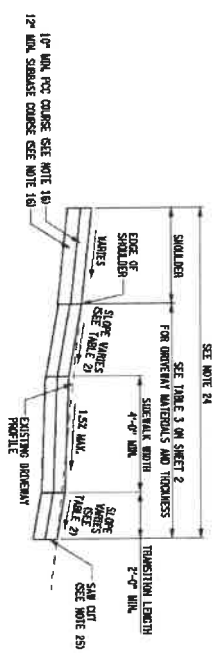
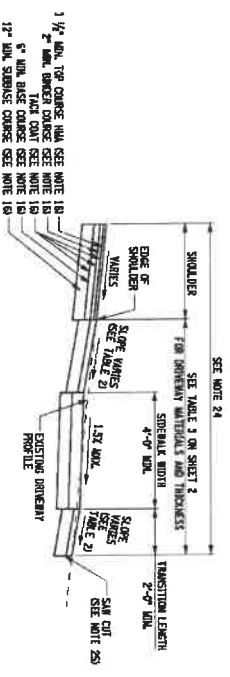
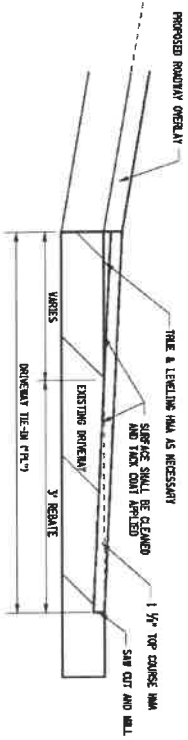
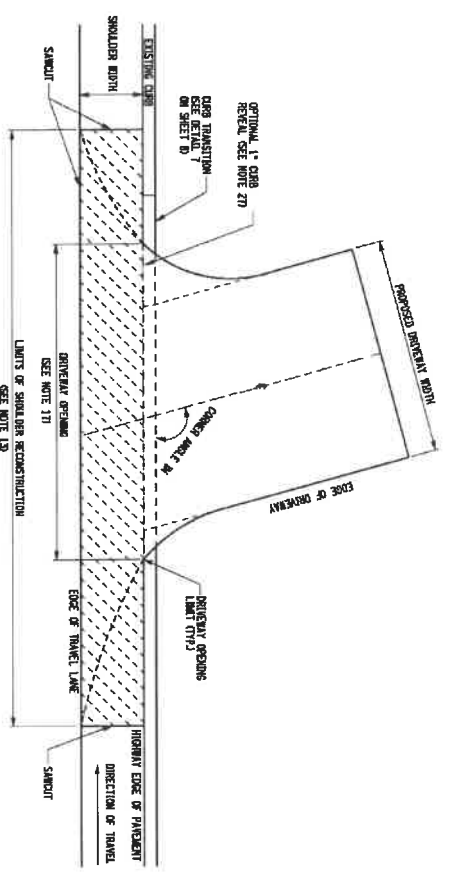

DETAIL 9  
 TYPICAL DRIVEWAY ENTRANCE  
 LIMITS OF SHOULDER RECONSTRUCTION

DETAIL 9  
 TIE-IN TO EXISTING DRIVEWAYS  
 FOR HOT MIX ASPHALT (HMA)

DETAIL 10  
 SHOULDER AND DRIVEWAY RECONSTRUCTION  
 PROFILE FOR HOT MIX ASPHALT (HMA) SHOULDER

DETAIL 11  
 SHOULDER AND DRIVEWAY RECONSTRUCTION  
 PROFILE FOR FCS SHOULDER

NOTE:  
 ALL GENERAL NOTES AND OBSERVATIONS REFERENCED ON THIS SHEET CAN BE FOUND ON STANDARD SHEET 608-03, SHEET 1 OF 3.

 NEW YORK STATE DEPARTMENT OF TRANSPORTATION U.S. DISTRICT COURT STAMPOUT SHEET		<b>Department of          Transportation</b>
<b>RESIDENTIAL AND MINOR COMMERCIAL DRIVEWAYS</b> SHEET 9 OF 91		
APPROVED MARCH 07, 2016 /s/ RICHARD B. LEE, P.E. DEPUTY CHIEF ENGINEER (DESIGN)	ISSUED UNDER E9 16-012 608-03	



# Bid Form

## Bid: CONCRETE SIDEWALK REPLACEMENT 2025

The undersigned hereby proposes to furnish all labor, materials, devices, appliances, supplies, equipment, services and other facilities necessary to complete all of the Contractor portion of the “**Specifications: Concrete Sidewalk Replacement 2025**” for the Town of Schroon as required by, and in accordance with, the provisions of the Instructions to Bidders, as prepared by the Town and dated 02/18/2025 and that, if this Proposal is accepted, the Undersigned agrees to enter an Agreement with the Town to perform this work for the following sum as listed below:

### Price List:

Per **Lineal Foot** of Curb: ..... \$ \_\_\_\_\_ /Ln. Ft.  
Per **Square Foot** of Sidewalk:..... \$ \_\_\_\_\_ /Sq. Ft.  
Per Detectable Warning Pad Installation: ..... \$ \_\_\_\_\_ /Unit

Company Name: \_\_\_\_\_

Company Address: \_\_\_\_\_

Company Phone: \_\_\_\_\_ EIN: \_\_\_\_\_

Signature: \_\_\_\_\_

Print Name: \_\_\_\_\_

Title: \_\_\_\_\_ Date: \_\_\_\_\_

**TOWN OF SCHROON COUNTY  
VENDOR RESPONSIBILITY QUESTIONNAIRE**

1. VENDOR IS:  ____ PRIME CONTRACTOR			
2. VENDOR'S LEGAL BUSINESS NAME		3. IDENTIFICATION NUMBERS A) FEIN # B) DUNS #	
4. D/B/A – Doing Business As (if applicable) & COUNTY FIELD		5. WEBSITE ADDRESS (if applicable)	
6. ADDRESS OF PRIMARY PLACE OF BUSINESS/EXECUTIVE OFFICE		7. TELEPHONE NUMBER	8. FAX NUMBER
9. ADDRESS OF PRIMARY PLACE OF BUSINESS/EXECUTIVE OFFICE <i>IN NEW YORK STATE, if different from above</i>		10. TELEPHONE NUMBER	11. FAX NUMBER
12. AUTHORIZED CONTACT FOR THIS QUESTIONNAIRE  Name  Title  Telephone Number  Fax Number  Email			
13. LIST ALL OF THE VENDOR'S PRINCIPAL OWNERS			
A) NAME	TITLE	B) NAME	TITLE
C) NAME	TITLE	D) NAME	TITLE
A DETAILED EXPLANATION IS REQUIRED FOR EACH QUESTION ANSWERED WITH A "YES," AND MUST BE PROVIDED AS AN ATTACHMENT TO THE COMPLETED QUESTIONNAIRE. YOU MUST PROVIDE ADEQUATE DETAILS OR DOCUMENTS TO AID THE COUNTY IN MAKE A DETERMINATION OF VENDOR RESPONSIBILITY. PLEASE NUMBER EACH RESPONSE TO MATCH THE QUESTION NUMBER.			
14. DOES THE VENDOR USE, OR HAS IT USED IN THE PAST FIVE (5) YEARS, ANY OTHER BUSINESS NAME, FEIN, or D/B/A OTHER THAN THOSE LISTED IN ITEMS 2-4 ABOVE? List all other business name(s), Federal Employer Identification Number(s) or any D/B/A names and the dates that these names or numbers were/are in use. Explain the relationship to the vendor			
15. ARE THERE ANY INDIVIDUALS NOW SERVING IN A MANAGERIAL OR CONSULTING CAPACITY TO THE VENDOR, INCLUDING PRINCIPAL OWNERS AND OFFICERS, WHO NOW SERVE OR IN THE PAST ONE (1) YEARS HAVE SERVED AS:			
a) An elected or appointed public official or officer? <i>List each individual's name, business title, the name of the organization and position elected or appointed to, and dates of service</i>		____ YES ____ NO	
b) An officer of any political party organization in Town of Schroon, whether paid or unpaid? <i>List each individuals name, business title or consulting capacity and the official political position held with applicable service dates.</i>		____ YES ____ NO	

16. WITHIN THE PAST (5) YEARS, HAS THE VENDOR, ANY INDIVIDUALS SERVING IN MANAGERIAL OR CONSULTING CAPACITY, PRINCIPAL, OWNERS, OFFICERS, MAJOR STOCKHOLDER(S) (10% OR MORE OF THE VOTING SHARES FOR PUBLICLY TRADED COMPANIES, 25% OR MORE OF THE SHARES FOR ALL OTHER COMPANIES), AFFILIATE OR ANY PERSON INVOLVED IN THE BIDDING OR CONTRACTING PROCESS:

- a) 1. been suspended, debarred or terminated by a local, state or federal authority in connection with a contract or contracting process; \_\_\_ YES \_\_\_ NO
2. been disqualified for cause as a bidder on any permit, license, concession, franchise or lease;
3. entered into an agreement to a voluntary exclusion from bidding/contracting;
4. had a bid rejected on an Essex County contract for failure to comply with the MacBride Fair Employment Principles;
5. had a low bid rejected on a local, state or federal contract for failure to meet statutory affirmative action or M/WBE requirements on a previously held contract;
6. had a status as a Women's Business Enterprise, Minority Business Enterprise or Disadvantaged Business Enterprise, de-certified, revoked or forfeited;
7. been subject to an administrative proceeding or civil action seeking specific performance or restitution in connection with any local, state or federal government contract;
8. been denied an award of a local, state or federal government contract, had a contract suspended or had a contract terminated for non-responsibility; or
9. had a local, state or federal government contract suspended or terminated for cause prior to the completion of the term of the contract.
- b) been indicted, convicted, received a judgment against them or a grant of immunity for any business-related conduct constituting a crime under local, state or federal law including but not limited to, fraud, extortion, bribery, racketeering, price-fixing, bid collusion or any crime related to truthfulness and/or business conduct? \_\_\_ YES \_\_\_ NO
- c) been issued a citation, notice, violation order, or are pending an administrative hearing or proceeding or determination of violations of: \_\_\_ YES \_\_\_ NO
1. federal, state or local health laws, rules or regulations

17. IN THE PAST THREE (3) YEARS, HAS THE VENDOR OR ITS AFFILIATES' HAD ANY CLAIMS, JUDGMENTS, INJUNCTIONS, LIENS, FINES OR PENALTIES SECURED BY ANY GOVERNMENTAL AGENCY?

\_\_\_ YES \_\_\_ NO

Indicate if this is applicable to the submitting vendor or affiliate. State whether the situation(s) was a claim, judgment, injunction, lien or other with an explanation. Provide the name(s) and address(es) of the agency, the amount of the original obligation and outstanding balance. If any of these items are open, unsatisfied, indicate the status of each items as "open" or "unsatisfied".

18. DURING THE PAST THREE (3) YEARS, HAS THE VENDOR FAILED TO:

- a) file returns or pay any applicable federal, state or city taxes?  
*Identify the taxing jurisdiction, type of tax, liability year(s), and tax liability amount the vendor failed to file/pay and the current status of the liability.* \_\_\_ YES \_\_\_ NO
- b) file returns or pay New York State unemployment insurance?  
*Indicate the years the vendor failed to file/pay the insurance and the current status of the liability.* \_\_\_ YES \_\_\_ NO
- c) Property Tax  
*Indicate the years the vendor failed to file.* \_\_\_ YES \_\_\_ NO

19. HAVE ANY BANKRUPTCY PROCEEDINGS BEEN INITIATED BY OR AGAINST THE VENDOR OR ITS AFFILIATES' WITHIN THE PAST SEVEN (7) YEARS (WHETHER OR NOT CLOSED) OR IS ANY BANKRUPTCY PROCEEDING PENDING BY OR AGAINST THE VENDOR OR ITS AFFILIATES REGARDLESS OF THE DATE OF FILING?

\_\_\_ YES \_\_\_ NO

Indicate if this is applicable to the submitting vendor or affiliate. If it is an affiliate, include the affiliate's name and FEIN. Provide the court name, address and docket number. Indicate if the proceedings have been initiated, remain pending or have been closed. If closed, provide the date closed.

20. IS THE VENDOR CURRENTLY INSOLVENT, OR DOES VENDOR CURRENTLY HAVE REASON TO BELIEVE THAT AN INVOLUNTARY BANKRUPTCY PROCEEDING MAY BE BROUGHT AGAINST IT?  YES  NO  
Provide financial information to support the vendor's current position, for example, Current Ration, Debt Ration, Age of Accounts Payable, Cash Flow and any documents that will provide the agency with an understanding of the vendor's situation.

21. IN THE PAST FIVE (5) YEARS, HAS THE VENDOR OR ANY AFFILIATES:  YES  NO  
a) defaulted or been terminated on, or had its surety called upon to complete, any contract (public or private) awarded;  
Indicate if this is applicable to the submitting vendor or affiliate. Detail the situation(s) that gave rise to the negative action, any corrective action taken by the vendor and the name of the contracting agency.

<sup>1</sup> "Affiliate" meaning: (a) any entity in which the vendor owns more than 50% of the voting stock; (b) any individual, entity or group of principal owners or officers who own more than 50% of the voting stock of the vendor; or (c) any entity whose voting stock is more than 50% owned by the same individual, entity or group described in clause (b). In addition, if a vendor owns less than 50% of the voting stock of another entity, but directs or has the right to direct such entity's daily operations, that entity will be an "affiliate" for purposes of this questionnaire.

**CERTIFICATION OF COMPLIANCE WITH THE IRAN DIVESTMENT ACT**

As a result of the Iran Divestment Act of 2012 (the "Act"), Chapter 1 of the 2012 Laws of New York, a new provision has been added to State Finance Law (SFL) § 165a and New York General Municipal Law § 103 -g, both effective April 12, 2012. Under the Act, the Commissioner of the Office of General Services (OGS) will be developing a list of "persons" who are engaged in "investment activities in Iran" (both are defined terms in the law) (the "Prohibited Entities List"). Pursuant to SFL §165-a(3)(b), the initial list is expected to be issued no later than 120 days after the Act's effective date at which time it will be posted on the OGS website.

By submitting a bid in response to this solicitation or by assuming the responsibility of a Contract awarded hereunder, each Bidder/Contractor, any person signing on behalf of any Bidder/Contractor and any assignee or subcontractor and, in the case of a joint bid, each party thereto, certifies, under penalty of perjury, that once the Prohibited Entities List is posted on the OGS website, that to the best of its knowledge and belief, that each Bidder/Contractor and any subcontractor or assignee is not identified on the Prohibited Entities List created pursuant to SFL § 165-a(3)(b).

Additionally, Bidder/Contractor is advised that once the Prohibited Entities List is posted on the OGS Website, any Bidder/Contractor seeking to renew or extend a Contract or assume the responsibility of a Contract awarded in response to this solicitation must certify at the time the Contract is renewed, extended or assigned that it is not included on the Prohibited Entities List.

During the term of the Contract, should the Town receive information that a Bidder/Contractor is in violation of the above-referenced certification, the Town will offer the person or entity an opportunity to respond. If the person or entity fails to demonstrate that he/she/it has ceased engagement in the investment which is in violation of the Act within 90 days after the determination of such violation, then the Town shall take such action as may be appropriate including, but not limited to, imposing sanctions, seeking compliance, recovering damages or declaring the Bidder/Contractor in default.

The Town reserves the right to reject any bid or request for assignment for a Bidder/Contractor that appears on the Prohibited Entities List prior to the award of a contract and to pursue a responsibility review with respect to any Bidder/Contractor that is awarded a contract and subsequently appears on the Prohibited Entities List.

I, \_\_\_\_\_, being duly sworn, deposes and says that he/she is the \_\_\_\_\_ of the \_\_\_\_\_ Corporation and that neither the Bidder/Contractor nor any proposed subcontractor is identified on the Prohibited Entities List.

SIGNED \_\_\_\_\_

SWORN to before me this \_\_\_\_\_  
day of \_\_\_\_\_, 20\_\_

\_\_\_\_\_  
Notary Public

**NON-COLLUSIVE BIDDING CERTIFICATE**  
**SEC 103-d GENERAL MUNICIPAL LAW**

By submission of this bid, each bidder and each person signing on behalf of any bidder certifies, and in the case of a joint bid, each party thereto certifies as to its own organization, under penalty of perjury, that to the best of his knowledge and behalf:

1. The price in this bid has been arrived at independently, without collusion, consultation, communication or agreement, for the purpose of restricting competition, as to any matter relating to such prices with any other bidder, or with any competitor;
2. Unless otherwise required by Law, the prices which have been quoted in this bid have not been knowingly disclosed by the bidder, prior to the opening, directly or indirectly to any other bidder or any other competitor; and
3. No attempt has been made or will be made by the bidder to induce any other person, partnership or corporation to submit a bid for the purpose of restricting competition.

I hereby affirm under the penalties of perjury that the foregoing statement is true.

SIGNED: \_\_\_\_\_

AFFIX SEAL IF  
PRINCIPAL IS CORPORATION



Kathy Hochul, Governor

Roberta Reardon, Commissioner

Town of Schroon  
Erica Hedden  
15 Leland Ave  
P.O. Box 578  
Schroon Lake NY 12870

Schedule Year 2024 through 2025  
Date Requested 02/18/2025  
PRC# 2025002012

Location Varies  
Project ID#  
Project Type removal and replacement of concrete sidewalk; removal and replacement of concrete curb; saw cutting, removal and replacement of asphalt in roadway; saw cutting and site restoration

### PREVAILING WAGE SCHEDULE FOR ARTICLE 8 PUBLIC WORK PROJECT

Attached is the current schedule(s) of the prevailing wage rates and prevailing hourly supplements for the project referenced above. A unique Prevailing Rate Case Number (PRC#) has been assigned to the schedule(s) for your project.

The schedule is effective from July 2024 through June 2025. All updates, corrections, posted on the 1st business day of each month, and future copies of the annual determination are available on the Department's website [www.labor.ny.gov](http://www.labor.ny.gov). Updated PDF copies of your schedule can be accessed by entering your assigned PRC# at the proper location on the website.

It is the responsibility of the contracting agency or its agent to annex and make part, the attached schedule, to the specifications for this project, when it is advertised for bids and /or to forward said schedules to the successful bidder(s), immediately upon receipt, in order to insure the proper payment of wages.

Please refer to the "General Provisions of Laws Covering Workers on Public Work Contracts" provided with this schedule, for the specific details relating to other responsibilities of the Department of Jurisdiction.

Upon completion or cancellation of this project, enter the required information and mail **OR** fax this form to the office shown at the bottom of this notice, **OR** fill out the electronic version via the NYSDOL website.

#### NOTICE OF COMPLETION / CANCELLATION OF PROJECT

Date Completed: \_\_\_\_\_ Date Cancelled: \_\_\_\_\_

Name & Title of Representative: \_\_\_\_\_

Phone: (518) 457-5589 Fax: (518) 485-1870  
W. Averell Harriman State Office Campus, Bldg. 12, Room 130, Albany, NY 12240

## **General Provisions of Laws Covering Workers on Article 8 Public Work Contracts**

### **Introduction**

The Labor Law requires public work contractors and subcontractors to pay laborers, workers, or mechanics employed in the performance of a public work contract not less than the prevailing rate of wage and supplements (fringe benefits) in the locality where the work is performed.

### **Responsibilities of the Department of Jurisdiction**

A Department of Jurisdiction (Contracting Agency) includes a state department, agency, board or commission; a county, city, town or village; a school district, board of education or board of cooperative educational services; a sewer, water, fire, improvement and other district corporation; a public benefit corporation; and a public authority awarding a public work contract.

The Department of Jurisdiction (Contracting Agency) awarding a public work contract MUST obtain a Prevailing Rate Schedule listing the hourly rates of wages and supplements due the workers to be employed on a public work project. This schedule may be obtained by completing and forwarding a "Request for wage and Supplement Information" form (PW 39) to the Bureau of Public Work. The Prevailing Rate Schedule MUST be included in the specifications for the contract to be awarded and is deemed part of the public work contract.

Upon the awarding of the contract, the law requires that the Department of Jurisdiction (Contracting Agency) furnish the following information to the Bureau: the name and address of the contractor, the date the contract was let and the approximate dollar value of the contract. To facilitate compliance with this provision of the Labor Law, a copy of the Department's "Notice of Contract Award" form (PW 16) is provided with the original Prevailing Rate Schedule.

The Department of Jurisdiction (Contracting Agency) is required to notify the Bureau of the completion or cancellation of any public work project. The Department's PW 200 form is provided for that purpose.

Both the PW 16 and PW 200 forms are available for completion online.

### **Hours**

No laborer, worker, or mechanic in the employ of a contractor or subcontractor engaged in the performance of any public work project shall be permitted to work more than eight hours in any day or more than five days in any week, except in cases of extraordinary emergency. The contractor and the Department of Jurisdiction (Contracting Agency) may apply to the Bureau of Public Work for a dispensation permitting workers to work additional hours or days per week on a particular public work project.

### **Wages and Supplements**

The wages and supplements to be paid and/or provided to laborers, workers, and mechanics employed on a public work project shall be not less than those listed in the current Prevailing Rate Schedule for the locality where the work is performed. If a prime contractor on a public work project has not been provided with a Prevailing Rate Schedule, the contractor must notify the Department of Jurisdiction (Contracting Agency) who in turn must request an original Prevailing Rate Schedule form the Bureau of Public Work. Requests may be submitted by: mail to NYSDOL, Bureau of Public Work, State Office Bldg. Campus, Bldg. 12, Rm. 130, Albany, NY 12226; Fax to Bureau of Public Work (518) 485-1870; or electronically at the NYSDOL website [www.labor.ny.gov](http://www.labor.ny.gov).

Upon receiving the original schedule, the Department of Jurisdiction (Contracting Agency) is REQUIRED to provide complete copies to all prime contractors who in turn MUST, by law, provide copies of all applicable county schedules to each subcontractor and obtain from each subcontractor, an affidavit certifying such schedules were received. If the original schedule expired, the contractor may obtain a copy of the new annual determination from the NYSDOL website [www.labor.ny.gov](http://www.labor.ny.gov).

The Commissioner of Labor makes an annual determination of the prevailing rates. This determination is in effect from July 1st through June 30th of the following year. The annual determination is available on the NYSDOL website [www.labor.ny.gov](http://www.labor.ny.gov).

### **Payrolls and Payroll Records**

Every contractor and subcontractor MUST keep original payrolls or transcripts subscribed and affirmed as true under penalty of perjury. As per Article 6 of the Labor law, contractors and subcontractors are required to establish, maintain, and preserve for not less than six (6) years, contemporaneous, true, and accurate payroll records. At a minimum, payrolls must show the following information for each person employed on a public work project: Name, Address, Last 4 Digits of Social Security Number, Classification(s) in which the worker was employed, Hourly wage rate(s) paid, Supplements paid or provided, and Daily and weekly number of hours worked in each classification.



The filing of payrolls to the Department of Jurisdiction is a condition of payment. Every contractor and subcontractor shall submit to the Department of Jurisdiction (Contracting Agency), within thirty (30) days after issuance of its first payroll and every thirty (30) days thereafter, a transcript of the original payrolls, subscribed and affirmed as true under penalty of perjury. The Department of Jurisdiction (Contracting Agency) shall collect, review for facial validity, and maintain such payrolls.

In addition, the Commissioner of Labor may require contractors to furnish, with ten (10) days of a request, payroll records sworn to as their validity and accuracy for public work and private work. Payroll records include, but are not limited to time cards, work description sheets, proof that supplements were provided, cancelled payroll checks and payrolls. Failure to provide the requested information within the allotted ten (10) days will result in the withholding of up to 25% of the contract, not to exceed \$100,000.00. If the contractor or subcontractor does not maintain a place of business in New York State and the amount of the contract exceeds \$25,000.00, payroll records and certifications must be kept on the project worksite.

The prime contractor is responsible for any underpayments of prevailing wages or supplements by any subcontractor.

All contractors or their subcontractors shall provide to their subcontractors a copy of the Prevailing Rate Schedule specified in the public work contract as well as any subsequently issued schedules. A failure to provide these schedules by a contractor or subcontractor is a violation of Article 8, Section 220-a of the Labor Law.

All subcontractors engaged by a public work project contractor or its subcontractor, upon receipt of the original schedule and any subsequently issued schedules, shall provide to such contractor a verified statement attesting that the subcontractor has received the Prevailing Rate Schedule and will pay or provide the applicable rates of wages and supplements specified therein. (See NYS Labor Laws, Article 8 . Section 220-a).

### **Determination of Prevailing Wage and Supplement Rate Updates Applicable to All Counties**

The wages and supplements contained in the annual determination become effective July 1st whether or not the new determination has been received by a given contractor. Care should be taken to review the rates for obvious errors. Any corrections should be brought to the Department's attention immediately. It is the responsibility of the public work contractor to use the proper rates. If there is a question on the proper classification to be used, please call the district office located nearest the project. Any errors in the annual determination will be corrected and posted to the NYS DOL website on the first business day of each month. Contractors are responsible for paying these updated rates as well, retroactive to July 1st.

When you review the schedule for a particular occupation, your attention should be directed to the dates above the column of rates. These are the dates for which a given set of rates is effective. To the extent possible, the Department posts rates in its possession that cover periods of time beyond the July 1st to June 30th time frame covered by a particular annual determination. Rates that extend beyond that instant time period are informational ONLY and may be updated in future annual determinations that actually cover the then appropriate July 1st to June 30th time period.

### **Withholding of Payments**

When a complaint is filed with the Commissioner of Labor alleging the failure of a contractor or subcontractor to pay or provide the prevailing wages or supplements, or when the Commissioner of Labor believes that unpaid wages or supplements may be due, payments on the public work contract shall be withheld from the prime contractor in a sufficient amount to satisfy the alleged unpaid wages and supplements, including interest and civil penalty, pending a final determination.

When the Bureau of Public Work finds that a contractor or subcontractor on a public work project failed to pay or provide the requisite prevailing wages or supplements, the Bureau is authorized by Sections 220-b and 235.2 of the Labor Law to so notify the financial officer of the Department of Jurisdiction (Contracting Agency) that awarded the public work contract. Such officer MUST then withhold or cause to be withheld from any payment due the prime contractor on account of such contract the amount indicated by the Bureau as sufficient to satisfy the unpaid wages and supplements, including interest and any civil penalty that may be assessed by the Commissioner of Labor. The withholding continues until there is a final determination of the underpayment by the Commissioner of Labor or by the court in the event a legal proceeding is instituted for review of the determination of the Commissioner of Labor.

The Department of Jurisdiction (Contracting Agency) shall comply with this order of the Commissioner of Labor or of the court with respect to the release of the funds so withheld.

### **Summary of Notice Posting Requirements**

The current Prevailing Rate Schedule must be posted in a prominent and accessible place on the site of the public work project. The prevailing wage schedule must be encased in, or constructed of, materials capable of withstanding adverse weather conditions and be titled "PREVAILING RATE OF WAGES" in letters no smaller than two (2) inches by two (2) inches.

The "Public Work Project" notice must be posted at the beginning of the performance of every public work contract, on each job site.

Every employer providing workers' compensation insurance and disability benefits must post notices of such coverage in the format prescribed by the Workers' Compensation Board in a conspicuous place on the jobsite.

Every employer subject to the NYS Human Rights Law must conspicuously post at its offices, places of employment, or employment training centers, notices furnished by the State Division of Human Rights.

Employers liable for contributions under the Unemployment Insurance Law must conspicuously post on the jobsite notices furnished by the NYS Department of Labor.

## **Apprentices**

Employees cannot be paid apprentice rates unless they are individually registered in a program registered with the NYS Commissioner of Labor. The allowable ratio of apprentices to journeymen in any craft classification can be no greater than the statewide building trade ratios promulgated by the Department of Labor and included with the Prevailing Rate Schedule. An employee listed on a payroll as an apprentice who is not registered as above or is performing work outside the classification of work for which the apprentice is indentured, must be paid the prevailing journeyworker's wage rate for the classification of work the employee is actually performing.

NYS DOL Labor Law, Article 8, Section 220-3, require that only apprentices individually registered with the NYS Department of Labor may be paid apprenticeship rates on a public work project. No other Federal or State Agency of office registers apprentices in New York State.

Persons wishing to verify the apprentice registration of any person must do so in writing by mail, to the NYSDOL Office of Employability Development / Apprenticeship Training, State Office Bldg. Campus, Bldg. 12, Albany, NY 12226 or by Fax to NYSDOL Apprenticeship Training (518) 457-7154. All requests for verification must include the name and social security number of the person for whom the information is requested.

The only conclusive proof of individual apprentice registration is written verification from the NYSDOL Apprenticeship Training Albany Central office. Neither Federal nor State Apprenticeship Training offices outside of Albany can provide conclusive registration information.

It should be noted that the existence of a registered apprenticeship program is not conclusive proof that any person is registered in that program. Furthermore, the existence or possession of wallet cards, identification cards, or copies of state forms is not conclusive proof of the registration of any person as an apprentice.

## **Interest and Penalties**

In the event that an underpayment of wages and/or supplements is found:

- Interest shall be assessed at the rate then in effect as prescribed by the Superintendent of Banks pursuant to section 14-a of the Banking Law, per annum from the date of underpayment to the date restitution is made.
- A Civil Penalty may also be assessed, not to exceed 25% of the total of wages, supplements, and interest due.

## **Debarment**

Any contractor or subcontractor and/or its successor shall be ineligible to submit a bid on or be awarded any public work contract or subcontract with any state, municipal corporation or public body for a period of five (5) years when:

- Two (2) willful determinations have been rendered against that contractor or subcontractor and/or its successor within any consecutive six (6) year period.
- There is any willful determination that involves the falsification of payroll records or the kickback of wages or supplements.

## **Criminal Sanctions**

Willful violations of the Prevailing Wage Law (Article 8 of the Labor Law) may be a felony punishable by fine or imprisonment of up to 15 years, or both.

## **Discrimination**

No employee or applicant for employment may be discriminated against on account of age, race, creed, color, national origin, sex, disability or marital status.

No contractor, subcontractor nor any person acting on its behalf, shall by reason of race, creed, color, disability, sex or national origin discriminate against any citizen of the State of New York who is qualified and available to perform the work to which the employment relates (NYS Labor Law, Article 8, Section 220-e(a)).

No contractor, subcontractor, nor any person acting on its behalf, shall in any manner, discriminate against or intimidate any employee on account of race, creed, color, disability, sex, or national origin (NYS Labor Law, Article 8, Section 220-e(b)).

The Human Rights Law also prohibits discrimination in employment because of age, marital status, or religion.

There may be deducted from the amount payable to the contractor under the contract a penalty of \$50.00 for each calendar day during which such person was discriminated against or intimidated in violation of the provision of the contract (NYS Labor Law, Article 8, Section 220-e(c) ).

The contract may be cancelled or terminated by the State or municipality. All monies due or to become due thereunder may be forfeited for a second or any subsequent violation of the terms or conditions of the anti-discrimination sections of the contract (NYS Labor Law, Article 8, Section 220-e(d) ).

Every employer subject to the New York State Human Rights Law must conspicuously post at its offices, places of employment, or employment training centers notices furnished by the State Division of Human Rights.

### **Workers' Compensation**

In accordance with Section 142 of the State Finance Law, the contractor shall maintain coverage during the life of the contract for the benefit of such employees as required by the provisions of the New York State Workers' Compensation Law.

A contractor who is awarded a public work contract must provide proof of workers' compensation coverage prior to being allowed to begin work.

The insurance policy must be issued by a company authorized to provide workers' compensation coverage in New York State. Proof of coverage must be on form C-105.2 (Certificate of Workers' Compensation Insurance) and must name this agency as a certificate holder.

If New York State coverage is added to an existing out-of-state policy, it can only be added to a policy from a company authorized to write workers' compensation coverage in this state. The coverage must be listed under item 3A of the information page.

The contractor must maintain proof that subcontractors doing work covered under this contract secured and maintained a workers' compensation policy for all employees working in New York State.

Every employer providing worker's compensation insurance and disability benefits must post notices of such coverage in the format prescribed by the Workers' Compensation Board in a conspicuous place on the jobsite.

### **Unemployment Insurance**

Employers liable for contributions under the Unemployment Insurance Law must conspicuously post on the jobsite notices furnished by the New York State Department of Labor.



Kathy Hochul, Governor

Roberta Reardon, Commissioner

Town of Schroon  
Erica Hedden  
15 Leland Ave  
P.O. Box 578  
Schroon Lake NY 12870

Schedule Year 2024 through 2025  
Date Requested 02/18/2025  
PRC# 2025002012

Location Varies  
Project ID#  
Project Type removal and replacement of concrete sidewalk; removal and replacement of concrete curb; saw cutting, removal and replacement of asphalt in roadway; saw cutting and site restoration

### Notice of Contract Award

New York State Labor Law, Article 8, Section 220.3a requires that certain information regarding the awarding of public work contracts, be furnished to the Commissioner of Labor. One "Notice of Contract Award" (PW 16, which may be photocopied), **MUST** be completed for **EACH** prime contractor on the above referenced project.

Upon notifying the successful bidder(s) of this contract, enter the required information and mail **OR** fax this form to the office shown at the bottom of this notice, **OR** fill out the electronic version via the NYSDOL website.

### Contractor Information

All information must be supplied

Federal Employer Identification Number: _____		
Name: _____		
Address: _____ _____		
City: _____	State: _____	Zip: _____
Amount of Contract: \$ _____	Contract Type:	
Approximate Starting Date: ____/____/____	<input type="checkbox"/> (01) General Construction	
Approximate Completion Date: ____/____/____	<input type="checkbox"/> (02) Heating/Ventilation	
	<input type="checkbox"/> (03) Electrical	
	<input type="checkbox"/> (04) Plumbing	
	<input type="checkbox"/> (05) Other : _____	

Phone: (518) 457-5589 Fax: (518) 485-1870  
W. Averell Harriman State Office Campus, Bldg. 12, Room 130, Albany, NY 12226

### **Social Security Numbers on Certified Payrolls:**

The Department of Labor is cognizant of the concerns of the potential for misuse or inadvertent disclosure of social security numbers. Identity theft is a growing problem and we are sympathetic to contractors' concern regarding inclusion of this information on payrolls if another identifier will suffice.

For these reasons, the substitution of the use of the last four digits of the social security number on certified payrolls submitted to contracting agencies on public work projects is now acceptable to the Department of Labor. This change does not affect the Department's ability to request and receive the entire social security number from employers during its public work/ prevailing wage investigations.

### **Construction Industry Fair Play Act: Required Posting for Labor Law Article 25-B § 861-d**

Construction industry employers must post the "Construction Industry Fair Play Act" notice in a prominent and accessible place on the job site. Failure to post the notice can result in penalties of up to \$1,500 for a first offense and up to \$5,000 for a second offense. The posting is included as part of this wage schedule. Additional copies may be obtained from the NYS DOL website, <https://dol.ny.gov/public-work-and-prevailing-wage>

If you have any questions concerning the Fair Play Act, please call the State Labor Department toll-free at 1-866-435-1499 or email us at: [dol.misclassified@labor.ny.gov](mailto:dol.misclassified@labor.ny.gov) .

### **Worker Notification: (Labor Law §220, paragraph a of subdivision 3-a)**

**Effective June 23, 2020**

This provision is an addition to the existing wage rate law, Labor Law §220, paragraph a of subdivision 3-a. It requires contractors and subcontractors to provide written notice to all laborers, workers or mechanics of the *prevailing wage and supplement rate* for their particular job classification *on each pay stub*\*. It also requires contractors and subcontractors to *post a notice* at the beginning of the performance of every public work contract *on each job site* that includes the telephone number and address for the Department of Labor and a statement informing laborers, workers or mechanics of their right to contact the Department of Labor if he/she is not receiving the proper prevailing rate of wages and/or supplements for his/her job classification. The required notification will be provided with each wage schedule, may be downloaded from our website [www.labor.ny.gov](http://www.labor.ny.gov) or be made available upon request by contacting the Bureau of Public Work at 518-457-5589. \*In the event the required information will not fit on the pay stub, an accompanying sheet or attachment of the information will suffice.

(12.20)

**To all State Departments, Agency Heads and Public Benefit Corporations  
IMPORTANT NOTICE REGARDING PUBLIC WORK ENFORCEMENT FUND**

## **Budget Policy & Reporting Manual**

# **B-610**

### **Public Work Enforcement Fund**

*effective date December 7, 2005*

---

#### **1. Purpose and Scope:**

This Item describes the Public Work Enforcement Fund (the Fund, PWEF) and its relevance to State agencies and public benefit corporations engaged in construction or reconstruction contracts, maintenance and repair, and announces the recently-enacted increase to the percentage of the dollar value of such contracts that must be deposited into the Fund. This item also describes the roles of the following entities with respect to the Fund:

- New York State Department of Labor (DOL),
- The Office of the State of Comptroller (OSC), and
- State agencies and public benefit corporations.

#### **2. Background and Statutory References:**

DOL uses the Fund to enforce the State's Labor Law as it relates to contracts for construction or reconstruction, maintenance and repair, as defined in subdivision two of Section 220 of the Labor Law. State agencies and public benefit corporations participating in such contracts are required to make payments to the Fund.

Chapter 511 of the Laws of 1995 (as amended by Chapter 513 of the Laws of 1997, Chapter 655 of the Laws of 1999, Chapter 376 of the Laws of 2003 and Chapter 407 of the Laws of 2005) established the Fund.

#### **3. Procedures and Agency Responsibilities:**

The Fund is supported by transfers and deposits based on the value of contracts for construction and reconstruction, maintenance and repair, as defined in subdivision two of Section 220 of the Labor Law, into which all State agencies and public benefit corporations enter.

Chapter 407 of the Laws of 2005 increased the amount required to be provided to this fund to .10 of one-percent of the total cost of each such contract, to be calculated at the time agencies or public benefit corporations enter into a new contract or if a contract is amended. The provisions of this bill became effective August 2, 2005.

**To all State Departments, Agency Heads and Public Benefit Corporations  
IMPORTANT NOTICE REGARDING PUBLIC WORK ENFORCEMENT FUND**

OSC will report to DOL on all construction-related ("D") contracts approved during the month, including contract amendments, and then DOL will bill agencies the appropriate assessment monthly. An agency may then make a determination if any of the billed contracts are exempt and so note on the bill submitted back to DOL. For any instance where an agency is unsure if a contract is or is not exempt, they can call the Bureau of Public Work at the number noted below for a determination. Payment by check or journal voucher is due to DOL within thirty days from the date of the billing. DOL will verify the amounts and forward them to OSC for processing.

For those contracts which are not approved or administered by the Comptroller, monthly reports and payments for deposit into the Public Work Enforcement Fund must be provided to the Administrative Finance Bureau at the DOL within 30 days of the end of each month or on a payment schedule mutually agreed upon with DOL.

Reports should contain the following information:

- Name and billing address of State agency or public benefit corporation;
- State agency or public benefit corporation contact and phone number;
- Name and address of contractor receiving the award;
- Contract number and effective dates;
- Contract amount and PWEF assessment charge (if contract amount has been amended, reflect increase or decrease to original contract and the adjustment in the PWEF charge); and
- Brief description of the work to be performed under each contract.

Checks and Journal Vouchers, payable to the "New York State Department of Labor" should be sent to:

Department of Labor  
Administrative Finance Bureau-PWEF Unit  
Building 12, Room 464  
State Office Campus  
Albany, NY 12226

Any questions regarding billing should be directed to NYSDOL's Administrative Finance Bureau-PWEF Unit at (518) 457-3624 and any questions regarding Public Work Contracts should be directed to the Bureau of Public Work at (518) 457-5589.

Required Notice under Article 25-B of the Labor Law

## **Attention All Employees, Contractors and Subcontractors: You are Covered by the Construction Industry Fair Play Act**

### **The law says that you are an employee unless:**

- You are free from direction and control in performing your job, **and**
- You perform work that is not part of the usual work done by the business that hired you, **and**
- You have an independently established business.

Your employer cannot consider you to be an independent contractor unless all three of these facts apply to your work.

**It is against the law for an employer to misclassify employees as independent contractors or pay employees off the books.**

**Employee Rights:** If you are an employee, you are entitled to state and federal worker protections. These include:

- Unemployment Insurance benefits, if you are unemployed through no fault of your own, able to work, and otherwise qualified,
- Workers' compensation benefits for on-the-job injuries,
- Payment for wages earned, minimum wage, and overtime (under certain conditions),
- Prevailing wages on public work projects,
- The provisions of the National Labor Relations Act, and
- A safe work environment.

It is a violation of this law for employers to retaliate against anyone who asserts their rights under the law. Retaliation subjects an employer to civil penalties, a private lawsuit or both.

**Independent Contractors:** If you are an independent contractor, **you must pay all taxes and Unemployment Insurance contributions required by New York State and Federal Law.**

**Penalties** for paying workers off the books or improperly treating employees as independent contractors:

- **Civil Penalty**                      First offense: Up to \$2,500 per employee  
    Subsequent offense(s): Up to \$5,000 per employee
- **Criminal Penalty**                First offense: Misdemeanor - up to 30 days in jail, up to a \$25,000 fine and debarment from performing public work for up to one year.  
    Subsequent offense(s): Misdemeanor - up to 60 days in jail or up to a \$50,000 fine and debarment from performing public work for up to 5 years.

**If you have questions about your employment status or believe that your employer may have violated your rights and you want to file a complaint, call the Department of Labor at (866) 435-1499 or send an email to [dol.misclassified@labor.ny.gov](mailto:dol.misclassified@labor.ny.gov). All complaints of fraud and violations are taken seriously. You can remain anonymous.**

**Employer Name:**

IA 999 (09/16)



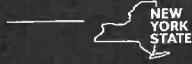

# Attention Employees

THIS IS A:

# PUBLIC WORK PROJECT

If you are employed on this project as a **worker, laborer, or mechanic** you are entitled to receive the **prevailing wage and supplements rate** for the classification at which you are working.

Your pay stub and wage notice received upon hire must clearly state your wage rate and supplement rate.

Chapter 629 of the Labor Laws of 2007:

**These wages are set by law and must be posted at the work site. They can also be found at:**  
**<https://dol.ny.gov/bureau-public-work>**



If you feel that you have not received proper wages or benefits, please call our nearest office.\*

Albany	(518) 457-2744	Patchogue	(631) 687-4882
Binghamton	(607) 721-8005	Rochester	(585) 258-4505
Buffalo	(716) 847-7159	Syracuse	(315) 428-4056
Garden City	(516) 228-3915	Utica	(315) 793-2314
New York City	(212) 932-2419	White Plains	(914) 997-9507
Newburgh	(845) 568-5287		

\* For New York City government agency construction projects, please contact the Office of the NYC Comptroller at (212) 669-4443, or [www.comptroller.nyc.gov](http://www.comptroller.nyc.gov) – click on Bureau of Labor Law.

Contractor Name: \_\_\_\_\_

Project Location: \_\_\_\_\_

## Requirements for OSHA 10 Compliance

Article 8 §220-h requires that when the advertised specifications, for every contract for public work, is \$250,000.00 or more the contract must contain a provision requiring that every worker employed in the performance of a public work contract shall be certified as having completed an OSHA 10 safety training course. The clear intent of this provision is to require that all employees of public work contractors, required to be paid prevailing rates, receive such training "prior to the performing any work on the project."

### The Bureau will enforce the statute as follows:

All contractors and sub contractors must attach a copy of proof of completion of the OSHA 10 course to the first certified payroll submitted to the contracting agency and on each succeeding payroll where any new or additional employee is first listed.

Proof of completion may include but is not limited to:

- Copies of bona fide course completion card (*Note: Completion cards do not have an expiration date.*)
- Training roster, attendance record or other documentation from the certified trainer pending the issuance of the card.
- Other valid proof

\*\*A certification by the employer attesting that all employees have completed such a course is not sufficient proof that the course has been completed.

Any questions regarding this statute may be directed to the New York State Department of Labor, Bureau of Public Work at 518-457-5589.

### WICKS

Public work projects are subject to the Wicks Law requiring separate specifications and bidding for the plumbing, heating and electrical work, when the total project's threshold is \$3 million in Bronx, Kings, New York, Queens and, Richmond counties; \$1.5 million in Nassau, Suffolk and Westchester counties; and \$500,000 in all other counties.

For projects below the monetary threshold, bidders must submit a sealed list naming each subcontractor for the plumbing, HVAC and electrical and the amount to be paid to each. The list may not be changed unless the public owner finds a legitimate construction need, including a change in specifications or costs or the use of a Project Labor Agreement (PLA), and must be open to public inspection.

Allows the state and local agencies and authorities to waive the Wicks Law and use a PLA if it will provide the best work at the lowest possible price. If a PLA is used, all contractors shall participate in apprentice training programs in the trades of work it employs that have been approved by the Department of Labor (DOL) for not less than three years. They shall also have at least one graduate in the last three years and use affirmative efforts to retain minority apprentices. PLA's would be exempt from Wicks, but deemed to be public work subject to prevailing wage enforcement.

The Commissioner of Labor shall have the power to enforce separate specification requirements on projects, and may issue stop-bid orders against public owners for non-compliance.

Other new monetary thresholds, and similar sealed bidding for non-Wicks projects, would apply to certain public authorities including municipal housing authorities, NYC Construction Fund, Yonkers Educational Construction Fund, NYC Municipal Water Finance Authority, Buffalo Municipal Water Finance Authority, Westchester County Health Care Association, Nassau County Health Care Corp., Clifton-Fine Health Care Corp., Erie County Medical Center Corp., NYC Solid Waste Management Facilities, and the Dormitory Authority.

Contractors must pay subcontractors within a 7 days period.

(07.19)

## Introduction to the Prevailing Rate Schedule

### Information About Prevailing Rate Schedule

This information is provided to assist you in the interpretation of particular requirements for each classification of worker contained in the attached Schedule of Prevailing Rates.

#### Classification

It is the duty of the Commissioner of Labor to make the proper classification of workers taking into account whether the work is heavy and highway, building, sewer and water, tunnel work, or residential, and to make a determination of wages and supplements to be paid or provided. It is the responsibility of the public work contractor to use the proper rate. If there is a question on the proper classification to be used, please call the district office located nearest the project. District office locations and phone numbers are listed below.

Prevailing Wage Schedules are issued separately for "General Construction Projects" and "Residential Construction Projects" on a county-by-county basis.

General Construction Rates apply to projects such as: Buildings, Heavy & Highway, and Tunnel and Water & Sewer rates.

Residential Construction Rates generally apply to construction, reconstruction, repair, alteration, or demolition of one family, two family, row housing, or rental type units intended for residential use.

Some rates listed in the Residential Construction Rate Schedule have a very limited applicability listed along with the rate. Rates for occupations or locations not shown on the residential schedule must be obtained from the General Construction Rate Schedule. Please contact the local Bureau of Public Work office before using Residential Rate Schedules, to ensure that the project meets the required criteria.

#### Payrolls and Payroll Records

Contractors and subcontractors are required to establish, maintain, and preserve for not less than six (6) years, contemporaneous, true, and accurate payroll records.

Every contractor and subcontractor shall submit to the Department of Jurisdiction (Contracting Agency), within thirty (30) days after issuance of its first payroll and every thirty (30) days thereafter, a transcript of the original payrolls, subscribed and affirmed as true under penalty of perjury.

#### Paid Holidays

Paid Holidays are days for which an eligible employee receives a regular day's pay, but is not required to perform work. If an employee works on a day listed as a paid holiday, this remuneration is in addition to payment of the required prevailing rate for the work actually performed.

#### Overtime

At a minimum, all work performed on a public work project in excess of eight hours in any one day or more than five days in any workweek is overtime. However, the specific overtime requirements for each trade or occupation on a public work project may differ. Specific overtime requirements for each trade or occupation are contained in the prevailing rate schedules.

Overtime holiday pay is the premium pay that is required for work performed on specified holidays. It is only required where the employee actually performs work on such holidays.

The applicable holidays are listed under HOLIDAYS: OVERTIME. The required rate of pay for these covered holidays can be found in the OVERTIME PAY section listings for each classification.

#### Supplemental Benefits

Particular attention should be given to the supplemental benefit requirements. Although in most cases the payment or provision of supplements is straight time for all hours worked, some classifications require the payment or provision of supplements, or a portion of the supplements, to be paid or provided at a premium rate for premium hours worked. Supplements may also be required to be paid or provided on paid holidays, regardless of whether the day is worked. The Overtime Codes and Notes listed on the particular wage classification will indicate these conditions as required.

#### Effective Dates

When you review the schedule for a particular occupation, your attention should be directed to the dates above the column of rates. These are the dates for which a given set of rates is effective. The rate listed is valid until the next effective rate change or until the new annual determination which takes effect on July 1 of each year. All contractors and subcontractors are required to pay the current prevailing rates of wages and supplements. If you have any questions please contact the Bureau of Public Work or visit the New York State Department of Labor website ([www.labor.ny.gov](http://www.labor.ny.gov)) for current wage rate information.

#### Apprentice Training Ratios

The following are the allowable ratios of registered Apprentices to Journey-workers.

For example, the ratio 1:1,1:3 indicates the allowable initial ratio is one Apprentice to one Journeyworker. The Journeyworker must be in place on the project before an Apprentice is allowed. Then three additional Journeyworkers are needed before a second Apprentice is allowed. The last ratio repeats indefinitely. Therefore, three more Journeyworkers must be present before a third Apprentice can be hired, and so on.

Please call Apprentice Training Central Office at (518) 457-6820 if you have any questions.

Title (Trade)	Ratio
Boilermaker (Construction)	1:1,1:4
Boilermaker (Shop)	1:1,1:3
Carpenter (Bldg.,H&H, Pile Driver/Dockbuilder)	1:1,1:4
Carpenter (Residential)	1:1,1:3
Electrical (Outside) Lineman	1:1,1:2
Electrician (Inside)	1:1,1:3
Elevator/Escalator Construction & Modernizer	1:1,1:2
Glazier	1:1,1:3
Insulation & Asbestos Worker	1:1,1:3
Iron Worker	1:1,1:4
Laborer	1:1,1:3
Mason	1:1,1:4
Millwright	1:1,1:4
Op Engineer	1:1,1:5
Painter	1:1,1:3
Plumber & Steamfitter	1:1,1:3
Roofer	1:1,1:2
Sheet Metal Worker	1:1,1:3
Sprinkler Fitter	1:1,1:2

If you have any questions concerning the attached schedule or would like additional information, please contact the nearest BUREAU of PUBLIC WORK District Office or write to:

New York State Department of Labor  
 Bureau of Public Work  
 State Office Campus, Bldg. 12  
 Albany, NY 12226

District Office Locations:	Telephone #	FAX #
Bureau of Public Work - Albany	518-457-2744	518-485-0240
Bureau of Public Work - Binghamton	607-721-8005	607-721-8004
Bureau of Public Work - Buffalo	716-847-7159	716-847-7650
Bureau of Public Work - Garden City	516-228-3915	516-794-3518
Bureau of Public Work - Newburgh	845-568-5287	845-568-5332
Bureau of Public Work - New York City	212-932-2419	212-775-3579
Bureau of Public Work - Patchogue	631-687-4882	631-687-4902
Bureau of Public Work - Rochester	585-258-4505	585-258-4708
Bureau of Public Work - Syracuse	315-428-4056	315-428-4671
Bureau of Public Work - Utica	315-793-2314	315-793-2514
Bureau of Public Work - White Plains	914-997-9507	914-997-9523
Bureau of Public Work - Central Office	518-457-5589	518-485-1870

**Essex County General Construction**

**Boilermaker**

**02/01/2025**

**JOB DESCRIPTION** Boilermaker

**DISTRICT 1**

**ENTIRE COUNTIES**

Albany, Broome, Chenango, Columbia, Delaware, Essex, Fulton, Greene, Hamilton, Herkimer, Montgomery, Otsego, Rensselaer, Saratoga, Schenectady, Schoharie, Tioga, Warren, Washington

**WAGES**

Per hour

07/01/2024

Boilermaker \$ 40.84

**SUPPLEMENTAL BENEFITS**

Per hour

Journeyworker \$26.51  
 + 1.49\*

(\*) This portion of the benefit is NOT subject to the SAME PREMIUM as shown for overtime.

**OVERTIME PAY**

See (B, E, Q, V) on OVERTIME PAGE

**HOLIDAY**

Paid: See (1) on HOLIDAY PAGE

Overtime: See (5, 6, 15, 25) on HOLIDAY PAGE

Note: When a holiday falls on Sunday, the day observed by the State or Nation shall be observed, and when Christmas Day and New Year's fall on Saturday, Friday will be observed as the holiday.

**REGISTERED APPRENTICES**

Wages per hour

( 1/2 ) year terms at the following percentage of Journeyman's wage.

1st	2nd	3rd	4th	5th	6th	7th	8th
65%	65%	70%	75%	80%	85%	90%	95%

Supplemental Benefits per hour

1st	2nd	3rd	4th	5th	6th	7th	8th
19.71	19.71	20.69	21.64	22.62	23.60	24.57	25.53
+1.49**	+1.49**	+1.49**	+1.49**	+1.49**	+1.49**	+1.49**	+1.49**

(\*\*) This portion of the benefit is NOT subject to the SAME PREMIUM as shown for overtime.

1-197

**Carpenter - Building**

**02/01/2025**

**JOB DESCRIPTION** Carpenter - Building

**DISTRICT 2**

**ENTIRE COUNTIES**

Clinton, Essex, Franklin, Hamilton, Washington

**WAGES**

Per hour:

07/01/2024

07/01/2025

Additional

Carpenter	\$ 30.68	\$ 1.00*
Floor Coverer	30.68	1.00*
Carpet Layer	30.68	1.00*
Dry-Wall	30.68	1.00*
Diver-Wet Day	61.25	0.00
Diver-Dry Day	31.68	1.00*
Diver Tender	31.68	1.00*

\*To be allocated at a later date

NOTE ADDITIONAL AMOUNTS PAID FOR THE FOLLOWING WORK LISTED BELOW (per hour worked):

- Pile Drivers/Dock Builders shall receive \$0.25 per hour over the journeyworker's rate of pay when performing piledriving/dock building work.

- Certified welders shall receive \$1.00 per hour over the journeyworker's rate of pay when the employee is required to be certified and performs DOT or ABS specified welding work
- When an employee performs work within a contaminated area on a State and/or Federally designated hazardous waste site, and where relevant State and/or Federal regulations require employees to be furnished and use or wear required forms of personal protection, then the employee shall receive his regular hourly rate plus \$1.50 per hour.
- Depth pay for Divers based upon deepest depth on the day of the dive (per diem payment):
  - 0' to 80' no additional fee
  - 81' to 100' additional \$.50 per foot
  - 101' to 150' additional \$0.75 per foot
  - 151' and deeper additional \$1.25 per foot
- Penetration pay for Divers based upon deepest penetration on the day of the dive (per diem payment):
  - 0' to 50' no additional fee
  - 51' to 100' additional \$.75 per foot
  - 101' and deeper additional \$1.00 per foot
- Diver rates applies to all hours worked on dive day.

**SHIFT WORK**

On Agency/Owner mandated shift work, the following rates will be applicable:

- 1st Shift - Regular Rate
- 2nd Shift - Premium of 7% of base wage per hour
- 3rd Shift - Premium of 14% of base wage per hour

Shift work shall be defined as implementing at least two (2) shifts in a twenty-four (24) consecutive hour period. Shift work must be for a minimum of three (3) consecutive days.

**SUPPLEMENTAL BENEFITS**

Per hour:

Journeyworker \$ 23.34

**OVERTIME PAY**

See (B, E, E2, Q) on OVERTIME PAGE

**HOLIDAY**

Paid: See (1) on HOLIDAY PAGE  
Overtime: See (5, 6) on HOLIDAY PAGE

Note: Any holiday which occurs on Sunday shall be observed the following Monday. If Christmas falls on a Saturday, it shall be observed on the prior Friday.

**REGISTERED APPRENTICES**

Wages per hour (1300 hour terms at the following percentage of Journeyworker's base wage):

1st	2nd	3rd	4th
65%	70%	75%	80%

Supplemental Benefits per hour:

\$ 12.15	\$ 12.15	\$ 14.75	\$ 14.75
----------	----------	----------	----------

NOTE ADDITIONAL AMOUNTS PAID TO APPRENTICES FOR THE FOLLOWING WORK LISTED BELOW (per hour worked):

- Pile Driving/Dock Builder apprentices shall receive an additional \$0.25 per hour worked when performing piledriving/dock building work.
- Certified Welders shall receive \$1.00 per hour over the apprentices rate of pay when the apprentice is required to be certified and performs DOT or ABS specified welding work.
- When an apprentice performs work within a contaminated area on a State and/or Federally designated hazardous waste site, and where relevant State and/or Federal regulations require the apprentice to be furnished and use or wear required forms of personal protection, then the apprentice shall receive his regular hourly rate plus \$1.50 per hour.

2-291B-ClI

**Carpenter - Building / Heavy&Highway**

02/01/2025

**JOB DESCRIPTION** Carpenter - Building / Heavy&Highway

**DISTRICT 2**

**ENTIRE COUNTIES**

Albany, Allegany, Broome, Cattaraugus, Cayuga, Chautauqua, Chemung, Chenango, Clinton, Columbia, Cortland, Delaware, Erie, Essex, Franklin, Fulton, Genesee, Greene, Hamilton, Herkimer, Jefferson, Lewis, Livingston, Madison, Monroe, Montgomery, Niagara, Oneida, Onondaga, Ontario, Orleans, Oswego, Otsego, Rensselaer, Saratoga, Schenectady, Schoharie, Schuyler, Seneca, St. Lawrence, Steuben, Sullivan, Tioga, Tompkins, Ulster, Warren, Washington, Wayne, Wyoming, Yates

**PARTIAL COUNTIES**

Orange: The area lying on Northern side of Orange County demarcated by a line drawn from the Bear Mountain Bridge continuing west to the Bear Mountain Circle, continue North on 9W to the town of Cornwall where County Road 107 (also known as Quaker Rd) crosses under 9W, then east on County Road 107 to Route 32, then north on Route 32 to Orrs Mills Rd, then west on Orrs Mills Rd to Route 94, continue west and south on Route 94 to the Town of Chester, to the intersection of Kings Highway, continue south on Kings Highway to Bellvale Rd, west on Bellvale Rd to Bellvale Lakes Rd, then south on Bellvale Lakes Rd to Kain Rd, southeast on Kain Rd to Route 17A, then north and southeast along Route 17A to Route 210, then follow Route 210 to NJ Border.

**WAGES**

Wages per hour:

07/01/2024

Carpenter - ONLY for  
 Artificial Turf/Synthetic  
 Sport Surface \$ 36.48

Note - Does not include the operation of equipment. Please see Operating Engineers rates.

**SUPPLEMENTAL BENEFITS**

Per hour:

Journeyworker \$ 26.55

**OVERTIME PAY**

See (B, E, Q, X) on OVERTIME PAGE

**HOLIDAY**

Paid: See (5) on HOLIDAY PAGE  
 Overtime: See (5, 6, 16) on HOLIDAY PAGE

Notes:

When a holiday falls upon a Saturday, it shall be observed on the preceding Friday. When a holiday falls upon a Sunday, it shall be observed on the following Monday.

An employee taking an unexcused day off the regularly scheduled day before or after a paid Holiday shall not receive Holiday pay.

**REGISTERED APPRENTICES**

Wages per hour (1300 hour terms at the following percentage of Journeyworker's wage):

1st	2nd	3rd	4th
65%	70%	75%	80%

Supplemental Benefits per hour:

\$18.58	\$19.14	\$21.24	\$21.79
---------	---------	---------	---------

2-42AtSS

**Carpenter - Heavy&Highway**

**02/01/2025**

**JOB DESCRIPTION** Carpenter - Heavy&Highway

**DISTRICT 2**

**ENTIRE COUNTIES**

Clinton, Essex, Franklin, Hamilton

**WAGES**

Per hour 07/01/2024

Carpenter	\$ 41.03
Piledriver	41.03
Diver-Wet Day	66.03
Diver-Dry Day	42.03
Diver-Tender	42.03

NOTE ADDITIONAL AMOUNTS PAID FOR THE FOLLOWING WORK LISTED BELOW (per hour worked):

- State or Federal designated hazardous site, requiring protective gear shall be an additional \$2.50 per hour.
- Certified welders when required to perform welding work will receive an additional \$2.50 per hour.

**ADDITIONAL NOTES PERTAINING TO DIVERS/TENDERS:**

- Divers and Tenders shall receive one and one half (1 1/2) times their regular diver and tender rate of pay for Effluent and Slurry diving.
- Divers and tenders being paid at the specified rate for Effluent and Slurry diving shall have all overtime rates based on the specified rate plus the appropriate overtime rates (one and one half or two times the specified rate for Slurry and Effluent divers and tenders).
- The pilot of an ADS or submersible will receive one and one-half (1 1/2) times the Diver-Wet Day Rate for time submerged.
- All crew members aboard a submersible shall receive the Diver-Wet Day rate.
- Depth pay for Divers based upon deepest depth on the day of the dive (per diem payment):
  - 0' to 50' no additional fee
  - 51'to 100' additional \$.50 per foot
  - 101'to 150' additional \$0.75 per foot
  - 151'and deeper additional \$1.25 per foot
- Penetration pay for Divers based upon deepest penetration on the day of the dive (per diem payment):
  - 0' to 50' no additional fee
  - 51' to 100' additional \$.75 per foot
  - 101' and deeper additional \$1.00 per foot
- Diver rates applies to all hours worked on dive day.

**SHIFT WORK**

When project owner mandates a single irregular work shift, the Journeyworkers and Apprentices will receive an additional \$3.00 per hour. A single irregular work shift can start any time from 5:00 p.m. to 1:00 a.m.

**SUPPLEMENTAL BENEFITS**

Per hour:

Journeyworker \$ 24.79

**OVERTIME PAY**

See (B, E, Q) on OVERTIME PAGE

**HOLIDAY**

Paid: See (5, 6) on HOLIDAY PAGE

Overtime: See (5, 6) on HOLIDAY PAGE

- In the event a Holiday falls on a Saturday, the Friday before will be observed as a Holiday. If a Holiday falls on a Sunday, then Monday will be observed as a Holiday.

- The employee must work their scheduled workday before and their scheduled workday after the holiday to receive holiday pay.

**REGISTERED APPRENTICES**

**CAPRENTER APPRENTICES**

Wages per hour (1040 hour terms at the following percentage of journeyworker's base wage):

1st	2nd	3rd	4th	5th
65%	70%	75%	80%	85%

Supplemental Benefits per hour:

\$ 18.27	\$ 18.84	\$ 20.90	\$ 21.46	\$ 22.02
----------	----------	----------	----------	----------

**PILEDRIVER/DOCKBUILDER APPRENTICES**

Wages per hour (1300 hour terms at the following percentage of journeyworker's base wage):

1st	2nd	3rd	4th
65%	70%	75%	80%

Supplemental Benefits per hour:

\$ 18.27	\$ 18.84	\$ 20.90	\$ 21.46
----------	----------	----------	----------

NOTE ADDITIONAL AMOUNTS PAID PER HOUR WORKED TO APPRENTICES FOR SPECIFIC TYPES OF WORK PERFORMED:

- State or Federal designated hazardous site, requiring protective gear shall be an additional \$2.50 per hour.

- Certified welders when required to perform welding work will receive an additional \$2.50 per hour.

2-291HH-CEFH

**Electrician**

02/01/2025

**JOB DESCRIPTION** Electrician

**DISTRICT 6**

**ENTIRE COUNTIES**

Clinton, Essex, Franklin, Jefferson, Lewis, St. Lawrence

**WAGES**

Per hour:	07/01/2024	04/01/2025	04/01/2026
Electrician	\$ 42.00	Additional \$ 2.75*	Additional \$ 2.60*
Teledata	42.00	2.75*	2.60*
Welder	44.00	2.75*	2.60*

\* To be allocated at a later date.

NOTE: Additional premiums for the following work listed (Amounts subject to premiums):

- Additional \$1.50 per hour for work performed underground such as tunnels and mine shafts. Excludes manholes and walkway tunnels between buildings.

- Additional \$1.50 per hour for working 35 feet or more on scaffolds, ladders, towers, steeples, structural steel, or mechanical lifts over 65 feet.

**SHIFT WORK**

THE FOLLOWING RATES WILL APPLY ON ALL CONTRACTING AGENCY MANDATED SHIFTS WORKED BETWEEN THE HOURS LISTED BELOW. THE EMPLOYER MAY BE PERMITTED TO ADJUST THE STARTING HOURS OF THE SHIFT BY UP TO TWO (2) HOURS IF REQUIRED BY THE AGENCY. IF A SHIFT BEGINS OUTSIDE OF THE STATED SHIFT HOURS, THE RATE PAID WOULD BE DETERMINED BY WHAT SHIFT THE MAJORITY OF HOURS WERE WORKED.

1st shift:	8:00 AM to 4:30 PM	Regular wage rate
2nd shift:	4:30 PM to 1:00 AM	Regular wage rate plus 17.3%
3rd shift:	12:30 AM to 9:00 AM	Regular wage rate plus 31.4%

**SUPPLEMENTAL BENEFITS**

Per hour:

Journeyworker \$ 24.63 plus  
 5.75% of hourly wage paid\*



\* NOTE: THE 5.75% IS BASED ON THE HOURLY WAGE PAID, STRAIGHT TIME RATE OR PREMIUM TIME RATE.

**OVERTIME PAY**

See (B, E, Q) on OVERTIME PAGE

WAGE CAP - Double the straight time hourly base wage shall be the maximum hourly wage compensation for any hour worked. Contractor is still responsible to pay the hourly benefit amount for each hour worked.

**HOLIDAY**

Paid: See (1) on HOLIDAY PAGE  
 Overtime: See (5, 6) on HOLIDAY PAGE

**REGISTERED APPRENTICES**

WAGES per hour: Hourly terms at the following percentage of Journeyworker's wage.

	1-1000 45%	to 2000 50%	to 3500 55%	to 5000 60%	to 6500 70%	to 8000 80%
Electrician	\$18.90	\$21.00	\$23.10	\$25.20	\$29.40	\$33.60
Tunnel	\$20.40	\$22.50	\$24.60	\$26.70	\$30.90	\$35.10

SUPPLEMENTAL BENEFITS per hour:

1st & 2nd term \$ 11.67\*

All other terms \$ 24.63\*

\* PLUS 5.75% OF HOURLY WAGE PAID, STRAIGHT TIME RATE OR PREMIUM TIME RATE.

6-910

**Elevator Constructor**

02/01/2025

**JOB DESCRIPTION** Elevator Constructor

**DISTRICT 1**

**ENTIRE COUNTIES**

Albany, Clinton, Essex, Fulton, Hamilton, Herkimer, Montgomery, Otsego, Rensselaer, Saratoga, Schenectady, Schoharie, Warren, Washington

**PARTIAL COUNTIES**

Madison: Madison Only the towns of: Brookfield, Hamilton, Lincoln, Madison, Smithfield, Stockbridge and the City of Oneida  
 Oneida: Entire county except the towns of: Camden, Florence, and Vienna.

**WAGES**

Per hour	07/01/2024	01/01/2025
Mechanic	\$ 55.32	\$ 57.73
Helper	70% of Mechanic Wage Rate	70% of Mechanic Wage Rate

**SUPPLEMENTAL BENEFITS**

Per hour	07/01/2024	01/01/2025
Journeyworker/Helper	\$ 37.885*	\$ 38.435*

(\*)Plus 6% of hourly rate, if less than 5 years of service. Plus 8% of hourly rate, if more than 5 years of service.

**OVERTIME PAY**

See (D, O) on OVERTIME PAGE

**HOLIDAY**

Paid: See (5, 6, 15, 16) on HOLIDAY PAGE  
 Overtime: See (5, 6, 15, 16) on HOLIDAY PAGE

Note: When a paid holiday falls on Saturday, it shall be observed on Friday. When a paid holiday falls on Sunday, it shall be observed on Monday.

**REGISTERED APPRENTICES**

Wages per hour:

0-6 mo*	6-12 mo	2nd yr	3rd yr	4th yr
50%	55%	65%	70%	80%

(\*)Plus 6% of the hourly rate, no additional supplemental benefits.

Supplemental Benefits - per hour worked:

Same as Journeyperson/Helper

1-35

**Glazier** **02/01/2025**

**JOB DESCRIPTION** Glazier

**DISTRICT 1**

**ENTIRE COUNTIES**

Albany, Clinton, Columbia, Essex, Franklin, Fulton, Greene, Hamilton, Montgomery, Rensselaer, Saratoga, Schenectady, Schoharie, Warren, Washington

**WAGES**

Per hour	07/01/2024	01/01/2025	05/01/2025 Additional + 1.80	07/01/2025 Additional
Glazier Base Wage	\$ 33.01	\$ 33.01		
Plus additional \$4.10 per hour for all hours worked, not subject to overtime/premium				
High Work Base Wage***	\$ 35.35	Additional \$ 2.00		+ 4.00

Plus additional \$4.10 per hour for all hours worked, not subject to overtime/premium

(\*\*\*)When working on Swing Stage or Lift 100 feet or more in height, measured from the ground level up.

**SHIFT WORK**

THE FOLLOWING RATES WILL APPLY ON ALL CONTRACTING AGENCY MANDATED SHIFT WORK OR SINGLE IRREGULAR SHIFTS STARTING BETWEEN THE HOURS LISTED BELOW:

4:00pm to 6:30am: **ADDITIONAL 12.5% TO APPLICABLE WAGE RATE AND SUPPLEMENTAL BENEFIT**

**SUPPLEMENTAL BENEFITS**

Per hour

Journeyworker	\$ 23.55
Journeyworker High Work	\$ 29.57

**OVERTIME PAY**

See (B, E, E2, Q) on OVERTIME PAGE  
 Premium is applied to the respective base wage only.

**HOLIDAY**

Paid: See (1) on HOLIDAY PAGE  
 Overtime: See (5, 6) on HOLIDAY PAGE

Note: If any of the holidays are designated by federal law to be celebrated on a day other than that on which they regularly fall, then the holiday shall be celebrated on the day set by said federal law as if the day on which the holiday is celebrated was actually the holiday date.

**REGISTERED APPRENTICES**

Wages per hour

Apprentice Glazier 1500 hr. terms at the following percentage of Journeyworkers base wage.

1st	2nd	3rd	4th
50%	65%	75%	90%
+ additional \$4.10 per hour for all hours worked for all terms			

Apprentice Glazier Hi-Work 1500 hr. terms at the following percentage of Journeyworkers Hi-Work base wage.

1st	2nd	3rd	4th
50%	65%	75%	90%
+ additional \$4.10 per hour for all hours worked for all terms			

Supplemental Benefits per hour worked

Apprentice	
1st term	\$ 19.88
2nd-4th term	23.55
Apprentice High Work	
1st term	23.72
2nd-4th term	29.57

**Insulator - Heat & Frost**

**02/01/2025**

**JOB DESCRIPTION** Insulator - Heat & Frost

**DISTRICT 1**

**ENTIRE COUNTIES**

Albany, Columbia, Delaware, Essex, Fulton, Greene, Hamilton, Montgomery, Rensselaer, Saratoga, Schenectady, Schoharie, Sullivan, Ulster, Warren, Washington

**WAGES**

Wages per hour 07/01/2024

Asbestos Worker*	\$ 40.46
Insulator*	40.46
Firestopping Worker*	34.40

(\* ) On Mechanical Systems only.

**SHIFT WORK**

On government mandated shift work additional 12% of wage for all shifts starting after 3:30 P.M.

**SUPPLEMENTAL BENEFITS**

Per hour

Journeyworker \$ 26.86

**OVERTIME PAY**

See (\*B1, \*\*Q) on OVERTIME PAGE

\*B1=Double time begins after 10 hours on Saturday

\*\*Q=Triple time on Labor Day if worked.

**HOLIDAY**

Paid: See (1) on HOLIDAY PAGE

Overtime: See (5, 6) on HOLIDAY PAGE

When a holiday falls on Sunday the following Monday shall be observed as the holiday.

**REGISTERED APPRENTICES**

Wages per hour

one year terms at the following percentage of Journeyperson's wage.

1st	2nd	3rd	4th
60 %	70 %	80 %	90 %

Supplemental Benefits per hour worked:

Apprentices \$ 26.86

1-40

**Ironworker**

**02/01/2025**

**JOB DESCRIPTION** Ironworker

**DISTRICT 1**

**ENTIRE COUNTIES**

Albany, Clinton, Columbia, Delaware, Essex, Greene, Rensselaer, Saratoga, Schenectady, Schoharie, Warren, Washington

**PARTIAL COUNTIES**

Fulton: Only the Townships of Broadalbin, Mayfield, Northampton, Bleecker and Johnstown.

Hamilton: Only the Townships of Hope, Benson and Wells.

Montgomery: Only the Townships of Florida, Amsterdam, Charleston, Glen, Mohawk and Root.

Otsego: Only the Towns of Unadilla, Butternuts, Morris, Otego, Oneonta, Laurens, Millford, Maryland and Worchester.

**WAGES**

Wages 07/01/2024 01/01/2025  
 Per hour

Ornamental	\$ 38.50	\$ 39.50
Reinforcing	38.50	39.50
Rodman	38.50	39.50
Structural & Precast	38.50	39.50
Mover/Rigger	38.50	39.50
Fence Erector	38.50	39.50
Stone Derrickman	38.50	39.50
Sheeter	38.75	39.75

Curtain Wall Installer	38.50	39.50
Metal Window Installer	38.50	39.50

**SHIFT WORK**

THE FOLLOWING RATE WILL APPLY ON ALL CONTRACTING AGENCY MANDATED SINGLE IRREGULAR SHIFTS:

Shift Starting 4:30 PM to 12:00 AM REGULAR RATE PLUS 10%

THE FOLLOWING RATES WILL APPLY ON ALL CONTRACTING AGENCY MANDATED MULTIPLE SHIFTWORK:

1st Shift	6:00 AM to 4:30 PM	REGULAR RATE
2nd Shift	2:00 PM to 7:00 PM	REGULAR RATE PLUS 10%
3rd Shift	7:00 PM to 12:00 AM	REGULAR RATE PLUS 15%

**SUPPLEMENTAL BENEFITS**

Per hour

JOURNEYWORKER	\$ 30.64	\$ 31.64
---------------	----------	----------

**OVERTIME PAY**

See (B, E, Q) on OVERTIME PAGE

**HOLIDAY**

Paid: See (1) on HOLIDAY PAGE  
 Overtime: See (4, 6) on HOLIDAY PAGE

Note: Any holiday which occurs on Sunday shall be observed the following Monday. Any holiday which occurs on Saturday shall be observed on the preceding Friday.

**REGISTERED APPRENTICES**

Wages per hour

ONE YEAR TERMS AT THE FOLLOWING WAGE RATES:

	07/01/2024
1st year	\$ 23.50
2nd year	25.50
3rd year	27.50
4th year	29.50

Supplemental Benefits per hour worked	
1st year	\$ 10.78
2nd year	22.87
3rd year	24.58
4th year	24.88

1-12

**Laborer - Building**

**02/01/2025**

**JOB DESCRIPTION** Laborer - Building

**DISTRICT 7**

**ENTIRE COUNTIES**

Clinton, Essex, Warren

**WAGES**

GROUP A: All Laborers (except as noted).  
 GROUP B: Asbestos & Hazardous Waste Work.  
 GROUP C: Wind & Solar Worker\*.

Per hour: 07/01/2024

Group A	\$ 28.03
Group B	29.53
Group C	28.53

\* Applies when performing delivery handling and site readiness for all solar panels and wind turbines, whether on land or water. Not applicable to the installation/assembly of solar photovoltaic panels or racking.

**SUPPLEMENTAL BENEFITS**

Per hour:

Journeyworker	\$ 24.55
---------------	----------

**OVERTIME PAY**

See (B, E, E2, Q) on OVERTIME PAGE

**HOLIDAY**

Paid: See (1) on HOLIDAY PAGE  
Overtime: See (5, 6) on HOLIDAY PAGE

**REGISTERED APPRENTICES**

WAGES per hour:

(1000 Hour) terms at the following percentages of Journeyworker's wage:

to 1000	to 2000	to 3000	to 4000
70%	80%	90%	95%

SUPPLEMENTAL BENEFITS per hour:

All Terms: Same as Journeyworker

7-1822ew

**Laborer - Heavy&Highway**

**02/01/2025**

**JOB DESCRIPTION** Laborer - Heavy&Highway

**DISTRICT 7**

**ENTIRE COUNTIES**

Clinton, Essex, Warren

**WAGES**

GROUP A: Drill Helper, Flagmen, Outboard and Hand Boats.

GROUP B: BASIC RATE: Bull Float (where used for strike off only), Chain Saw, Concrete Aggregate Bin, Concrete Bootman, Gin Buggy, Hand or Machine Vibrator, Jack Hammer, Mason Tender, Mortar Mixer, Pavement Breaker, Handlers of All Steel Mesh, Small Generators for Laborers' Tools, Installation of Bridge Drainage Pipe, Pipe Layers, Vibrator Type Rollers, Tamper, Drill Doctor, Water Pump Operator (1-1/2" and Single Diaphragm) Nozzle (Asphalt, Gunite, Seeding, and Sand Blasting), Laborers on Chain Link Fence Erection, Rock Splitter & Power Unit, Pusher Type Concrete Saw and All Other Gas, Electric, Oil, and Air Tool Operators, Wrecking Laborer.

GROUP C: Drilling Equipment - only where a separate air compressor unit supplies power, Acetylene Torch Operators, Asphalt Raker, Powder Man, Tail or Screw Operator on Asphalt Paver.

GROUP D: Blasters, Form Setters, Stone or Granite Curb Setters.

GROUP E: Hazardous Waste Removal Work when designated by State/Federal as hazardous waste site and regulations require employees wear required personal protection.

Per hour: 07/01/2024

GROUP A	\$ 33.32
GROUP B	33.52
GROUP C	33.72
GROUP D	33.92
GROUP E	36.52

**SHIFT WORK**

A single irregular work shift starting any time between 5:00 PM and 1:00 AM on governmental mandated night work shall be paid an additional \$3.00 per hour. Night work, when mandated by DOT shall be paid an additional \$3.00 per hour.

**SUPPLEMENTAL BENEFITS**

Per hour:

Journeyworker \$ 28.30

**OVERTIME PAY**

See (B, E, Q) on OVERTIME PAGE

**HOLIDAY**

Paid: See (5, 6) on HOLIDAY PAGE  
Overtime: See (5, 6) on HOLIDAY PAGE

NOTE: If a holiday falls on Saturday, it will be celebrated on Saturday. Employees who work a Saturday holiday shall be paid double time plus the holiday pay. If a holiday falls on Sunday, it will be celebrated on Monday. Employees who work a Sunday holiday shall be paid double time. Employees who work on Monday shall be paid double time plus the holiday pay. Accordingly, the Monday following the Sunday is treated as the holiday.

**REGISTERED APPRENTICES**

WAGES per hour: 1000 hour terms at the following percentage of Journeyworker's GROUP B wage.

1st	2nd	3rd	4th
-----	-----	-----	-----

70%      80%      90%      95%

SUPPLEMENTAL BENEFITS per hour:

All Terms: Same as Journeyworker

7-1822/2h

**Laborer - Tunnel**

**02/01/2025**

**JOB DESCRIPTION** Laborer - Tunnel

**DISTRICT 7**

**ENTIRE COUNTIES**

Clinton, Essex, Warren

**WAGES**

GROUP A: General Laborer.

GROUP B: Changehouse men, Miners and all Machine Men, Safety Miner, all Shaft-work, Caisson work, Drilling, Blow Pipe, all Air Tools, Tugger, Scaling, Nipper, Guniting pot to nozzle, Bit Grinder, Signal Man (top and bottom), Concrete Men, Shield driven tunnels, mixed face and soft ground, liner plate tunnels in free air.

GROUP C: Hazardous Waste Work on a State and or Federally designated waste site, and where relevant regulations require employees to use personal protection.

Per hour:                      07/01/2024

GROUP A                      \$ 36.50

GROUP B                      36.70

GROUP C                      39.50

**SHIFT WORK**

A single irregular work shift starting any time between 5:00 PM and 1:00 AM on governmental mandated night work shall be paid an additional \$3.00 per hour.

**SUPPLEMENTAL BENEFITS**

Per hour:

Journeyworker              \$ 28.30

**OVERTIME PAY**

See (B, E, Q) on OVERTIME PAGE

**HOLIDAY**

Paid:                              See (5, 6) on HOLIDAY PAGE

Overtime:                        See (5, 6) on HOLIDAY PAGE

NOTE: If a holiday falls on Saturday, it will be celebrated on Friday. If a holiday falls on Sunday, it will be celebrated on Monday. In the event that men work on this Sunday holiday, they shall be paid double time. In the event that men work on Monday, they shall be compensated at triple time. Accordingly, the Monday following the Sunday is treated as the holiday.

**REGISTERED APPRENTICES**

WAGES per hour: 1000 hour terms at the following percentage of Journeyworker's GROUP B wage:

1st	2nd	3rd	4th
70%	80%	90%	95%

SUPPLEMENTAL BENEFITS per hour:

All Terms: Same as Journeyworker

7-1822T

**Lineman Electrician**

**02/01/2025**

**JOB DESCRIPTION** Lineman Electrician

**DISTRICT 6**

**ENTIRE COUNTIES**

Albany, Allegany, Broome, Cattaraugus, Cayuga, Chautauqua, Chemung, Chenango, Clinton, Columbia, Cortland, Delaware, Dutchess, Erie, Essex, Franklin, Fulton, Genesee, Greene, Hamilton, Herkimer, Jefferson, Lewis, Livingston, Madison, Monroe, Montgomery, Niagara, Oneida, Onondaga, Ontario, Orange, Orleans, Oswego, Otsego, Putnam, Rensselaer, Rockland, Saratoga, Schenectady, Schoharie, Schuyler, Seneca, St. Lawrence, Steuben, Sullivan, Tioga, Tompkins, Ulster, Warren, Washington, Wayne, Wyoming, Yates

**WAGES**

A Lineman/Technician shall perform all overhead aerial work. A Lineman/Technician on the ground will install all electrical panels, connect all grounds, install and connect all electrical conductors, assembly of all electrical materials, conduit, pipe, or raceway; placing of fish wire; pulling of cables, wires or fiber optic cable through such raceways; splicing of conductors; dismantling of such structures, lines or equipment.

Crane Operators: Operation of any type of crane on line projects.  
 Crawler Backhoe: Operation of tracked excavator/crawler backhoe with 1/2 yard bucket or larger on line projects.  
 Digging Machine Operator: All other digging equipment and augering on line projects.

A Groundman/Truck Driver shall: Build and set concrete forms, handle steel mesh, set footer cages, transport concrete in a wheelbarrow, hand or machine concrete vibrator, finish concrete footers, mix mortar, grout pole bases, cover and maintain footers while curing in cold weather, operate jack hammer, operate hand pavement breaker, tamper, concrete and other motorized saws, as a drill helper, operate and maintain generators, water pumps, chainsaws, sand blasting, operate mulching and seeding machine, air tools, electric tools, gas tools, load and unload materials, hand shovel and/or broom, prepare and pour mastic and other fillers, assist digger operator/equipment operator in ground excavation and restoration, landscape work and painting. Only when assisting a lineman technician, a groundman/truck driver may assist in installing conduit, pipe, cables and equipment.

NOTE: Includes Teledata Work within ten (10) feet of High Voltage Transmission Lines. Also includes digging of holes for poles, anchors, footer, and foundations for electrical equipment.

Below rates applicable on all overhead and underground distribution and maintenance work, and all overhead and underground transmission line work and the installation of fiber optic cable where no other construction trades are or have been involved. Includes access matting for line work.

Per hour: 07/01/2024

Group A:	
Lineman, Technician	\$ 58.90
Crane, Crawler Backhoe	58.90
Welder, Cable Splicer	58.90

Group B:	
Digging Mach. Operator	53.01
Tractor Trailer Driver	50.07
Groundman, Truck Driver	47.12
Equipment Mechanic	47.12
Flagman	35.34

Additional \$1.00 per hour for entire crew when a helicopter is used.

Below rates applicable on all electrical sub-stations, switching structures, fiber optic cable and all other work not defined as "Utility outside electrical work." Includes access matting for line work.

Group A:	
Lineman, Technician	\$ 58.90
Crane, Crawler Backhoe	58.90
Cable Splicer	64.79
Certified Welder, Pipe Type Cable	61.85

Group B:	
Digging Mach. Operator	53.01
Tractor Trailer Driver	50.07
Groundman, Truck Driver	47.12
Equipment Mechanic	47.12
Flagman	35.34

Additional \$1.00 per hour for entire crew when a helicopter is used.

Below rates applicable on all switching structures, maintenance projects, railroad catenary install/maintenance third rail installation, bonding of rails and pipe type cable and installation of fiber optic cable. Includes access matting for line work.

Group A:	
Lineman, Tech, Welder	\$ 60.22
Crane, Crawler Backhoe	60.22
Cable Splicer	66.24
Certified Welder, Pipe Type Cable	63.23

Group B:	
Digging Mach. Operator	54.20

Tractor Trailer Driver	51.19
Groundman, Truck Driver	48.18
Equipment Mechanic	48.18
Flagman	36.13

Additional \$1.00 per hour for entire crew when a helicopter is used.

Below rates applicable on all overhead and underground transmission line work & fiber optic cable where other construction trades are or have been involved. This applies to transmission line work only, not other construction. Includes access matting for line work.

Group A:

Lineman, Tech, Welder	\$ 61.41
Crane, Crawler Backhoe	61.41

Group B:

Digging Mach. Operator	55.27
Tractor Trailer Driver	52.20
Groundman, Truck Driver	49.13
Equipment Mechanic	49.13
Flagman	36.85

Additional \$1.00 per hour for entire crew when a helicopter is used.

**SHIFT WORK**

THE FOLLOWING RATES WILL APPLY ON ALL CONTRACTING AGENCY MANDATED MULTIPLE SHIFTS OF AT LEAST FIVE (5) DAYS DURATION WORKED BETWEEN THE HOURS LISTED BELOW:

1ST SHIFT	8:00 AM to 4:30 PM REGULAR RATE
2ND SHIFT	4:30 PM to 1:00 AM REGULAR RATE PLUS 17.3 %
3RD SHIFT	12:30 AM to 9:00 AM REGULAR RATE PLUS 31.4 %

**SUPPLEMENTAL BENEFITS**

Per hour: 07/01/2024

Group A \$ 30.90  
 \*plus 7% of the hourly wage paid

Group B \$ 26.90  
 \*plus 7% of the hourly wage paid

\*The 7% is based on the hourly wage paid, straight time or premium time.

**OVERTIME PAY**

See (B, E, Q, X) on OVERTIME PAGE. NOTE: Double time for all emergency work designated by the Dept. of Jurisdiction.  
 WAGE CAP - Double the straight time hourly base wage shall be the maximum hourly wage compensation for any hour worked. Contractor is still responsible to pay the hourly benefit amount for each hour worked.

**HOLIDAY**

Paid See ( 5, 6, 8, 13, 25 ) on HOLIDAY PAGE plus Governor of NYS Election Day.  
 Overtime See ( 5, 6, 8, 13, 25 ) on HOLIDAY PAGE plus Governor of NYS Election Day.

NOTE: All paid holidays falling on Saturday shall be observed on the preceding Friday. All paid holidays falling on Sunday shall be observed on the following Monday. Supplements for holidays paid at straight time.

**REGISTERED APPRENTICES**

WAGES per hour: 1000 hour terms at the following percentage of the applicable Journeyworker's Lineman wage.

1st	2nd	3rd	4th	5th	6th	7th
60%	65%	70%	75%	80%	85%	90%

SUPPLEMENTAL BENEFITS per hour: 07/01/2024

\$ 26.90  
 \*plus 7% of



the hourly  
 wage paid

\*The 7% is based on the hourly wage paid, straight time or premium time.

6-1249a

**Lineman Electrician - Teledata**

**02/01/2025**

**JOB DESCRIPTION** Lineman Electrician - Teledata

**DISTRICT 6**

**ENTIRE COUNTIES**

Albany, Allegany, Broome, Cattaraugus, Cayuga, Chautauqua, Chemung, Chenango, Clinton, Columbia, Cortland, Delaware, Dutchess, Erie, Essex, Franklin, Fulton, Genesee, Greene, Hamilton, Herkimer, Jefferson, Lewis, Livingston, Madison, Monroe, Montgomery, Niagara, Oneida, Onondaga, Ontario, Orange, Orleans, Otsego, Putnam, Rensselaer, Rockland, Saratoga, Schenectady, Schoharie, Schuyler, Seneca, St. Lawrence, Steuben, Sullivan, Tioga, Tompkins, Ulster, Warren, Washington, Wayne, Westchester, Wyoming, Yates

**WAGES**

Per hour:

For outside work, stopping at first point of attachment (demarcation).

	07/01/2024	01/01/2025
Cable Splicer	\$ 39.24	\$ 40.81
Installer, Repairman	\$ 37.24	\$ 38.73
Teledata Lineman	\$ 37.24	\$ 38.73
Tech., Equip. Operator	\$ 37.24	\$ 38.73
Groundman	\$ 19.74	\$ 20.53

NOTE: EXCLUDES Teledata work within ten (10) feet of High Voltage (600 volts and over) transmission lines. For this work please see LINEMAN.

**SHIFT WORK**

THE FOLLOWING RATES APPLY WHEN THE CONTRACTING AGENCY MANDATES MULTIPLE SHIFTS OF AT LEAST FIVE (5) DAYS DURATION ARE WORKED. WHEN TWO (2) OR THREE (3) SHIFTS ARE WORKED THE FOLLOWING RATES APPLY:

1ST SHIFT	REGULAR RATE
2ND SHIFT	REGULAR RATE PLUS 10%
3RD SHIFT	REGULAR RATE PLUS 15%

**SUPPLEMENTAL BENEFITS**

Per hour:	07/01/2024	01/01/2025
Journeyworker	\$ 5.70	\$ 5.70
	*plus 3% of the hour wage paid	*plus 3% of the hour wage paid

\*The 3% is based on the hourly wage paid, straight time rate or premium rate.

**OVERTIME PAY**

See (B, E, Q) on OVERTIME PAGE

WAGE CAP - Double the straight time hourly base wage shall be the maximum hourly wage compensation for any hour worked. Contractor is still responsible to pay the hourly benefit amount for each hour worked.

**HOLIDAY**

Paid: See (1) on HOLIDAY PAGE  
 Overtime: See (5, 6, 16) on HOLIDAY PAGE

6-1249LT - Teledata

**Lineman Electrician - Traffic Signal, Lighting**

**02/01/2025**

**JOB DESCRIPTION** Lineman Electrician - Traffic Signal, Lighting

**DISTRICT 6**

**ENTIRE COUNTIES**

Albany, Allegany, Broome, Cattaraugus, Cayuga, Chautauqua, Chemung, Chenango, Clinton, Cortland, Delaware, Erie, Essex, Franklin, Fulton, Genesee, Greene, Hamilton, Herkimer, Jefferson, Lewis, Livingston, Madison, Monroe, Montgomery, Niagara, Oneida, Onondaga, Ontario, Orleans, Oswego, Otsego, Rensselaer, Saratoga, Schenectady, Schoharie, Schuyler, Seneca, St. Lawrence, Steuben, Sullivan, Tioga, Tompkins, Warren, Washington, Wayne, Wyoming, Yates

**WAGES**

Lineman/Technician shall perform all overhead aerial work. A Lineman/Technician on the ground will install all electrical panels, connect all grounds, install and connect all electrical conductors which includes, but is not limited to road loop wires; conduit and plastic or other type pipes that carry conductors, flex cables and connectors, and to oversee the encasement or burial of such conduits or pipes.

Crane Operators: Operation of any type of crane on Traffic Signal/Lighting projects.  
Crawler Backhoe: Operation of tracked excavator/crawler backhoe with 1/2 yard bucket or larger on Traffic Signal/Lighting projects.  
Digging Machine Operator: All other digging equipment and augering on Traffic Signal/Lighting projects.

A Groundman/Truck Driver shall: Build and set concrete forms, handle steel mesh, set footer cages, transport concrete in a wheelbarrow, hand or machine concrete vibrator, finish concrete footers, mix mortar, grout pole bases, cover and maintain footers while curing in cold weather, operate jack hammer, operate hand pavement breaker, tamper, concrete and other motorized saws, as a drill helper, operate and maintain generators, water pumps, chainsaws, sand blasting, operate mulching and seeding machine, air tools, electric tools, gas tools, load and unload materials, hand shovel and/or broom, prepare and pour mastic and other fillers, assist digger operator/equipment operator in ground excavation and restoration, landscape work and painting. Only when assisting a lineman technician, a groundman/truck driver may assist in installing conduit, pipe, cables and equipment.

A flagger's duties shall consist of traffic control only.

Per hour: 07/01/2024

Group A:  
Lineman, Technician \$ 50.54  
Crane, Crawler Backhoe 50.54  
Certified Welder 53.07

Group B:  
Digging Machine 45.49  
Tractor Trailer Driver 42.96  
Groundman, Truck Driver 40.43  
Equipment Mechanic 40.43  
Flagman 30.32

Above rates are applicable for installation, testing, operation, maintenance and repair on all Traffic Control (Signal) and Illumination (Lighting) projects, Traffic Monitoring Systems, and Road Weather Information Systems. Includes digging of holes for poles, anchors, footer foundations for electrical equipment; assembly of all electrical materials or raceway; placing of fish wire; pulling of cables, wires or fiber optic cable through such raceways; splicing of conductors; dismantling of such structures, lines or equipment.

**SHIFT WORK**

THE FOLLOWING RATES WILL APPLY ON ALL CONTRACTING AGENCY MANDATED MULTIPLE SHIFTS OF AT LEAST FIVE (5) DAYS DURATION WORKED BETWEEN THE HOURS LISTED BELOW:

1ST SHIFT	8:00 AM TO 4:30 PM	REGULAR RATE
2ND SHIFT	4:30 PM TO 1:00 AM	REGULAR RATE PLUS 17.3%
3RD SHIFT	12:30 AM TO 9:00 AM	REGULAR RATE PLUS 31.4%

**SUPPLEMENTAL BENEFITS**

Per hour worked:

07/01/2024

Group A \$ 30.90  
\*plus 7% of the hourly wage paid

Group B \$ 26.90  
\*plus 7% of the hourly wage paid

\*The 7% is based on the hourly wage paid, straight time or premium time.

**OVERTIME PAY**

See (B, E, Q, X) on OVERTIME PAGE. NOTE: Double time for all emergency work designated by the Dept. of Jurisdiction.  
WAGE CAP - Double the straight time hourly base wage shall be the maximum hourly wage compensation for any hour worked. Contractor is still responsible to pay the hourly benefit amount for each hour worked.

**HOLIDAY**

Paid: See ( 5, 6, 8, 13, 25 ) on HOLIDAY PAGE plus Governor of NYS Election Day.  
Overtime: See ( 5, 6, 8, 13, 25 ) on HOLIDAY PAGE plus Governor of NYS Election Day.

NOTE: All paid holidays falling on Saturday shall be observed on the preceding Friday. All paid holidays falling on Sunday shall be observed on the following Monday. Supplements for holidays paid at straight time.

**REGISTERED APPRENTICES**

WAGES per hour: 1000 hour terms at the following percentage of the applicable Journeyworker's Lineman wage.

1st	2nd	3rd	4th	5th	6th	7th
60%	65%	70%	75%	80%	85%	90%

SUPPLEMENTAL BENEFITS per hour:

07/01/2024

\$ 26.90  
 \*plus 7% of  
 the hourly  
 wage paid

\*The 7% is based on the hourly wage paid, straight time or premium time.

6-1249a-LT

**Lineman Electrician - Tree Trimmer**

**02/01/2025**

**JOB DESCRIPTION** Lineman Electrician - Tree Trimmer

**DISTRICT 6**

**ENTIRE COUNTIES**

Albany, Allegany, Broome, Cattaraugus, Cayuga, Chautauqua, Chemung, Chenango, Clinton, Columbia, Cortland, Delaware, Dutchess, Erie, Essex, Franklin, Fulton, Genesee, Greene, Hamilton, Herkimer, Jefferson, Lewis, Livingston, Madison, Monroe, Montgomery, Niagara, Oneida, Onondaga, Ontario, Orange, Orleans, Oswego, Otsego, Putnam, Rensselaer, Rockland, Saratoga, Schenectady, Schoharie, Schuyler, Seneca, St. Lawrence, Steuben, Sullivan, Tioga, Tompkins, Ulster, Warren, Washington, Wayne, Wyoming, Yates

**WAGES**

Applies to line clearance, tree work and right-of-way preparation on all new or existing energized overhead or underground electrical, telephone and CATV lines. This also includes stump removal near underground energized electrical lines including telephone and CATV lines.

Per hour: 07/01/2024

Tree Trimmer	\$ 31.44
Equipment Operator	27.80
Equipment Mechanic	27.80
Truck Driver	23.15
Groundman	19.07
Flag person	15.00*

\*NOTE-Rate effective on 01/01/2025 - \$15.50 due to minimum wage increase.

**SUPPLEMENTAL BENEFITS**

Per hour:

07/01/2024

Journeyworker	\$ 10.48 *plus 4.5% of the hourly wage paid
---------------	--

\* The 4.5% is based on the hourly wage paid, straight time rate or premium rate.

**OVERTIME PAY**

See (B, E, Q, X) on OVERTIME PAGE

WAGE CAP - Double the straight time hourly base wage shall be the maximum hourly wage compensation for any hour worked. Contractor is still responsible to pay the hourly benefit amount for each hour worked.

**HOLIDAY**

Paid: See (5, 6, 8, 15) on HOLIDAY PAGE  
 Overtime: See (5, 6, 8, 15, 16, 25) on HOLIDAY PAGE

NOTE: All paid holidays falling on a Saturday shall be observed on the preceding Friday. All paid holidays falling on a Sunday shall be observed on the following Monday.

6-1249TT

**Mason - Building**

**02/01/2025**

**JOB DESCRIPTION** Mason - Building

**DISTRICT 12**

**ENTIRE COUNTIES**

Albany, Clinton, Columbia, Essex, Franklin, Fulton, Greene, Hamilton, Montgomery, Rensselaer, Saratoga, Schenectady, Schoharie, Warren, Washington

**WAGES**

Per hour 07/01/2024

Tile/Marble/Terrazzo

Setter \$ 37.71  
Finisher 29.38

**SUPPLEMENTAL BENEFITS**

Per hour worked

Journeyman Setter \$ 21.83  
Journeyman Finisher 18.87

**OVERTIME PAY**

See (B, E, E2, Q) on OVERTIME PAGE

**HOLIDAY**

Paid: See (1) on HOLIDAY PAGE  
Overtime: See (5, 6) on HOLIDAY PAGE

**REGISTERED APPRENTICES**

Wages per hour

Hour Terms at the following percentage of Journeyman's wage

Setter:  
1st term 0-500 hrs 60%  
2nd term 501-1500 hrs 70%  
3rd term 1501-2500 hrs 80%  
4th term 2501-3500 hrs 85%  
5th term 3501-4500 hrs 90%  
6th term 4501-6000 hrs 95%

Finisher:  
1st term 0-500 hrs 70%  
2nd term 501-1500 hrs 80%  
3rd term 1501-2500 hrs 90%  
4th term 2501-3700 hrs 95%

Supplemental Benefits per hour worked 07/01/2024

Setter:  
1st term 0-500 hrs \$ 12.98  
2nd term 501-1500 hrs 12.98  
3rd term 1501-2500 hrs 17.40  
4th term 2501-3500 hrs 17.40  
5th term 3501-4500 hrs 19.61  
6th term 4501-6000 hrs 21.83

Finisher:  
1st term 0-500 hrs \$ 12.22  
2nd term 501-1500 hrs 12.22  
3rd term 1501-2500 hrs 15.54  
4th term 2501-3700 hrs 15.54

12-2TS.1

---

**Mason - Building**

02/01/2025

**JOB DESCRIPTION** Mason - Building

**DISTRICT** 12

**ENTIRE COUNTIES**  
Clinton, Essex, Franklin

**PARTIAL COUNTIES**  
Warren: Only the Townships of Chester, Hague, Horicon and Johnsburg.

**WAGES**

Per hour 07/01/2024

Bricklayer \$ 36.66

Cement Finisher	36.66
Plasterer/Fireproofers*	36.66
Pointer/Caulker/Cleaner	36.66
Stone Mason	36.66
Acid Brick	36.66

(\*Fireproofers on Structural only.

**SUPPLEMENTAL BENEFITS**

Per hour worked

Journeyman \$ 22.20

**OVERTIME PAY**

See (B, E, E2, Q) on OVERTIME PAGE

**HOLIDAY**

Paid: See (1) on HOLIDAY PAGE

Overtime: See (5, 6) on HOLIDAY PAGE

Note: Any holiday which occurs on Sunday shall be observed the following Monday.

**REGISTERED APPRENTICES**

Wages per hour

750 hr terms at the following percentage of Journeyman's wage

1st	2nd	3rd	4th	5th	6th	7th	8th
60%	60%	65%	70%	75%	80%	85%	90%

Supplemental Benefits per hour worked

All Terms \$ 22.20

12-2b.8

**Mason - Heavy&Highway**

02/01/2025

**JOB DESCRIPTION** Mason - Heavy&Highway

**DISTRICT** 12

**ENTIRE COUNTIES**

Albany, Cayuga, Clinton, Columbia, Essex, Franklin, Fulton, Greene, Hamilton, Herkimer, Jefferson, Lewis, Madison, Montgomery, Oneida, Oswego, Rensselaer, Saratoga, Schenectady, Schoharie, St. Lawrence, Warren, Washington

**PARTIAL COUNTIES**

Onondaga: For Heavy & Highway Cement Mason or Plaster Work in Onondaga County, refer to Mason-Heavy&Highway tag 12-2h/h on.

**WAGES**

Per hour

07/01/2024

Mason & Bricklayer \$ 42.26

Additional \$1.00 per hour for work on any swing scaffold or staging suspended by means of ropes or cables.

**SUPPLEMENTAL BENEFITS**

Per hour worked

Journeyman \$ 22.43

**OVERTIME PAY**

See (B, E, E2, Q) on OVERTIME PAGE

**HOLIDAY**

Paid: See (1) on HOLIDAY PAGE

Overtime: See (5, 6) on HOLIDAY PAGE

**REGISTERED APPRENTICES**

Wages per hour

750 HR TERMS at the following percent of Journeyman's wage

1st	2nd	3rd	4th	5th	6th	7th	8th
60%	60%	65%	70%	75%	80%	85%	90%

Supplemental Benefits per hour worked

0 to 500 Hours \$ 13.68  
 All Other 22.43

12-2hh.1

**Millwright**

**02/01/2025**

**JOB DESCRIPTION** Millwright

**DISTRICT 6**

**ENTIRE COUNTIES**

Albany, Allegany, Broome, Cattaraugus, Cayuga, Chautauqua, Chemung, Chenango, Clinton, Columbia, Cortland, Delaware, Erie, Essex, Franklin, Fulton, Genesee, Greene, Hamilton, Herkimer, Jefferson, Lewis, Livingston, Madison, Monroe, Montgomery, Niagara, Oneida, Onondaga, Ontario, Orleans, Oswego, Otsego, Rensselaer, Saratoga, Schenectady, Schoharie, Schuyler, Seneca, St. Lawrence, Steuben, Sullivan, Tioga, Tompkins, Ulster, Warren, Washington, Wayne, Wyoming, Yates

**WAGES**

THE FOLLOWING RATE APPLIES TO ANY GAS/STEAM TURBINE AND OR RELATED COMPONENT WORK, INCLUDING NEW INSTALLATIONS OR MAINTENANCE AND ANY/ALL WORK PERFORMED WITHIN THE PROPERTY LIMITS OF A NUCLEAR FACILITY.

Per hour:	07/01/2024	07/01/2025
		Additional
Millwright - Power Generation	\$ 45.00	\$2.50*

\* To be allocated at a later date.

NOTE: ADDITIONAL PREMIUMS PAID FOR THE FOLLOWING WORK LISTED BELOW (amount subject to any overtime premiums):

- Certified Welders shall receive an additional \$1.75 per hour provided they are directed to perform Certified Welding.
- If a work site has been declared a hazardous site by the Owner and the use of protective gear (including, as a minimum, air purifying canister-type chemical respirators) is required, then that employee shall receive an additional \$1.50 per hour.
- An employee performing the work of a machinist shall receive an additional \$2.00 per hour. For the purposes of this premium to apply, a "machinist" is a person who uses a lathe, Bridgeport, milling machine or similar type of tool to make or modify parts.
- When performing work underground at 500 feet and below, the employee shall receive an additional \$1.00 per hour.

**SUPPLEMENTAL BENEFITS**

Per hour paid:

Journeyworker \$ 27.95\*

\*NOTE: Subject to OT premium

**OVERTIME PAY**

See (B, E, E2, Q, V) on OVERTIME PAGE

**HOLIDAY**

Paid: See (1) on HOLIDAY PAGE  
 Overtime: See (5, 6) on HOLIDAY PAGE

NOTE: Any holiday that falls on Sunday shall be observed the following Monday. Any holiday that falls on Saturday shall be observed the preceding Friday.

**REGISTERED APPRENTICES**

WAGES per hour: One year terms at the following percentage of Journeyworker's wage:

Appr. 1st year	65 %*
Appr. 2nd year	75 %*
Appr. 3rd year	80 %*
Appr. 4th year	90 %*

\*NOTE: Additional premium for the following work listed below:

Certified Welder	\$ 1.75
Hazardous Waste Work	1.50
Machinist	2.00
Underground (500' and below)	1.00

SUPPLEMENTAL BENEFITS per hour:

Appr. 1st year	\$ 11.89
Appr. 2nd year	23.14
Appr. 3rd year	24.74
Appr. 4th year	26.35

6-1163Power

**Millwright**

**02/01/2025**

**JOB DESCRIPTION** Millwright

**DISTRICT 2**

**ENTIRE COUNTIES**

Clinton, Essex, Franklin, Hamilton, Jefferson, Lewis, Oneida, Onondaga, Oswego, St. Lawrence, Warren, Washington

**WAGES**

Per hour:	07/01/2024	07/01/2025
		Additional
Building	\$ 36.32	\$ 3.00*
Heavy & Highway	39.82	3.00*

\*To be allocated at a later date

NOTE ADDITIONAL PREMIUMS PAID FOR THE FOLLOWING WORK LISTED BELOW (amount subject to any overtime premiums):

- Certified Welders shall receive \$1.75 per hour in addition to the current Millwrights rate provided he/she is directed to perform certified welding.
- For Building work if a work site has been declared a hazardous site by the Owner and the use of protective gear (including, as a minimum, air purifying canister-type chemical respirators) are required, then that employee shall receive a \$1.50 premium per hour for Building work.
- For Heavy & Highway work if the work is performed at a State or Federally designated hazardous waste site where employees are required to wear protective gear, the employees performing the work shall receive an additional \$2.00 per hour over the millwright heavy and highway wage rate for all hours worked on the day protective gear was worn.
- An employee performing the work of a machinist shall receive \$2.00 per hour in addition to the current Millwrights rate. For the purposes of this premium to apply, a "machinist" is a person who uses a lathe, Bridgeport, milling machine or similar type of tool to make or modify parts.
- When performing work underground at 500 feet and below, the employee shall receive an additional \$1.00.

**SUPPLEMENTAL BENEFITS**

Per hour:

Journeyworker \$ 26.59

**OVERTIME PAY**

See (B, E, E2, Q) on OVERTIME PAGE

**HOLIDAY**

Paid: See (1) on HOLIDAY PAGE  
 Overtime: See (5, 6) on HOLIDAY PAGE

Note: Any holiday that falls on Sunday shall be observed the following Monday. Any holiday that falls on Saturday shall be observed the preceding Friday.

**REGISTERED APPRENTICES**

Wages per hour:

(1)year terms at the following percentage of Journeyworker's rate.

1st	2nd	3rd	4th
65%	75%	80%	90%

Supplemental Benefits per hour:

Apprentices:	
1st term	\$ 11.89
2nd term	22.19
3rd term	23.65
4th term	25.13

2-1163.2

**Operating Engineer - Building**

**02/01/2025**

**JOB DESCRIPTION** Operating Engineer - Building

**DISTRICT 1**

**ENTIRE COUNTIES**

Albany, Clinton, Columbia, Essex, Franklin, Fulton, Greene, Hamilton, Herkimer, Montgomery, Otsego, Rensselaer, Saratoga, Schenectady, Schoharie, Warren, Washington

**PARTIAL COUNTIES**

Dutchess: Defined as north of the northern boundary line of City of Poughkeepsie then due east to Route 115 to Bedell Road then east along Bedell Road to VanWagner Road then north along VanWagner Road to Bower Road then east along Bower Road to Rte. 44 east to Route 343 then along Route 343 east to the northern boundary of Town of Dover Plains and east along the northern boundary of Town of Dover Plains to Connecticut.

**WAGES**

NOTE:

- In the event that equipment listed below is operated by robotic control, the classification covering the operation will be the same as if manually operated.
- If a second employee is required by the employer for operation of any covered machine, they shall be an Engineer Class C

**CLASS A1\*:** All cranes that require A NYS crane license, tower cranes\*\*(including self erecting), hydraulic cranes, locomotive crane, piledriver, cableway, derricks, whirlies, dragline, boom trucks, cherry pickers, overhead cranes (gantry or saddle type), truck cranes

**CLASS A:**  
 Shovel, Excavators 18,001 lbs. and above(including rubber tire full swing), Gradalls, power road grader, all CMI equipment, front-end rubber tire loader, tractor-mounted drill (quarry master), mucking machine, concrete central mix plant, concrete pump, belcrete system, automated asphalt concrete plant, and tractor road paver, boom trucks 5 tons and under, maintenance engineer, self-contained crawler drill-hydraulic rock drill, Profiler/Milling machine.

**CLASS B:**  
 Excavators 18,000 lbs. and under, Backhoes (rubber tired backhoe/loader combination), bulldozer, pushcat, tractor, traxcavator, scraper, LeTourneau grader, form fine grader, self-propelled soil compactor (fill roller), asphalt roller, blacktop spreader, power brooms, sweepers, trenching machine, Barber Green loader, side booms, hydro hammer, concrete spreader, concrete finishing machine, one drum hoist, power hoisting (single drum), hoist two drum or more, three drum engine, power hoisting (two drum and over), two drum and swinging engine, three drum swinging engine, hod hoist, A-L frame winches, core and well drillers (one drum), post hole digger, model CHB Vibro-Tamp or similar machine, batch bin and plant operator, dinky locomotive, skid steer loader, track excavator 5/8 cubic yard or smaller, front end rubber tired loader under four cubic yards, vacuum machine (mounted or towed).

**CLASS C:**  
 Fork lift, high lift, all terrain fork lift: or similar, oiler, fireman and heavy-duty greaser, boilers and steam generators, pump, vibrator, motor mixer, air compressor, dust collector, welding machine, well point, mechanical heater, generators, temporary light plants, electric submersible pumps 4" and over, murphy type diesel generator, conveyor, elevators, concrete mixer, belcrete power pack (belcrete system), seeding, and mulching machines, pumps, rotating telehandler (that does not require NYS crane license).

**WAGES per hour**

	07/01/2024	07/01/2025
Class A1*	\$ 53.11	\$ 55.42
Class A	52.62	54.93
Class B	51.60	53.91
Class C	48.70	51.01

**(\*) TONNAGE RATING PREMIUMS:**

- Note: Additional value subject to same premiums as shown for OT
- All cranes 1000 tons and over, A1 rate plus \$7.00
- All cranes 800-999 tons, A1 rate plus \$6.00
- All cranes 600-799 tons, A1 rate plus \$5.00
- All cranes 400-599 tons, A1 rate plus \$4.00
- All cranes 200-399 tons, A1 rate plus \$3.00
- All cranes 111-199 tons, A1 rate plus \$2.25
- All cranes 110 tons and under, A1 rate only

(\*\*)Additional \$0.50 per hr on A1 rate for Tower Cranes (no tonnage premiums apply)

Additional \$2.50 per hr over B rate for Nuclear Leader work.

Additional \$2.50 per hour if work requires Personal Protective Equipment for hazardous waste site activities with a level C or over rating.

**SUPPLEMENTAL BENEFITS**

Per hour

	07/01/2024	07/01/2025
Journeyworker	\$ 32.40	\$ 33.50

**OVERTIME PAY**

See (B, E, Q) on OVERTIME PAGE

**HOLIDAY**

Paid: See (1) on HOLIDAY PAGE  
 Overtime: See (5, 6) on HOLIDAY PAGE

NOTE: All hours worked on designated holidays shall be paid a double the hourly rate of pay plus 8 hours of straight time.

NOTE: If a holiday falls on Sunday, it will be celebrated on Monday. If the holiday falls on Saturday, it will be celebrated on Friday.

**REGISTERED APPRENTICES**

Wages per hour

1000 hours terms at the following percentage of Journeyworker's wage Class B



1st	2nd	3rd	4th
60%	70%	80%	90%

Supplemental Benefits per hour worked

	07/01/2024	07/01/2025
All terms	\$ 27.70	\$ 28.80

1-158 Alb

**Operating Engineer - Heavy&Highway**

**02/01/2025**

**JOB DESCRIPTION** Operating Engineer - Heavy&Highway

**DISTRICT 1**

**ENTIRE COUNTIES**

Albany, Broome, Chenango, Clinton, Columbia, Essex, Franklin, Fulton, Greene, Hamilton, Herkimer, Montgomery, Otsego, Rensselaer, Saratoga, Schoenectady, Schoharie, Tioga, Warren, Washington

**PARTIAL COUNTIES**

Dutchess: Defined as north of the northern boundary line of City of Poughkeepsie then due east to Route 115 to Bedell Road then east along Bedell Road to VanWagner Road then north along VanWagner Road to Bower Road then east along Bower Road to Rte. 44 east to Route 343 then along Route 343 east to the northern boundary of Town of Dover Plains and east along the northern boundary of Town of Dover Plains to Connecticut.

**WAGES**

NOTE:

--- In the event that equipment listed below is operated by robotic control, the classification covering the operation will be the same as if manually operated.

--- If a second employee is required by the employer for operation of any covered machine, they shall be an Engineer Class C

CLASSIFICATION A1\*: All Cranes that require a NYS Crane License; tower cranes(including self erecting)\*\*, hydraulic cranes, locomotive crane, piledriver, cableway, derricks, whirlies, dragline, boom trucks, cherry pickers, overhead cranes (gantry or saddle type), truck cranes

**CLASSIFICATION A:**

Asphalt Curb Machine (Self Propelled, Slipform), Asphalt Paver, Automated Concrete Spreader (CMI Type), Automatic Fine Grader, Backhoe (Except Tractor Mounted, Rubber Tired), Backhoe Excavator Full Swing (CAT 212 or similar type), Back Filling Machine, Belt Placer (CMI Type), Blacktop Plant (Automated), Blacktop Roller, Boom truck, GPS operated Bull Dozer, Cableway, Caisson Auger, Central Mix Concrete Plant (Automated), Concrete Curb Machine (Self Propelled, Slipform), Concrete Pump, Crane, Cherry Picker, Derricks (steel erection), Dragline, Overhead Crane (Gantry or Straddle type), Pile Driver, Truck Crane, Directional Drilling Machine, Dredge, Dual Drum Paver, Excavator (All Purpose Hydraulically Operated) (Gradall or Similar), Front End Loader (4 cu. yd. and Over), Head Tower (Sauerman or Equal), Hoist (Two or Three Drum), Holland Loader, Maintenance Engineer, Mine Hoist, Mucking Machine or Mole, PB-4 and similar type, Power Grader, Profiler/Milling Machine (over 105 H.P.), Quad 9, Quarry Master (or equivalent), Rotating Telehandler, Scraper (Including Challenger Type), Shovel, Side Boom, Slip Form Paver (If a second man is needed, he shall be an Oiler), Tractor Drawn BeltType Loader, Truck or Trailer Mounted Log Chipper (Self Feeder), Tug Operator (Manned Rented Equipment Excluded), Tunnel Shovel

**CLASSIFICATION B:**

Backhoe (Tractor Mounted, Rubber Tired), Bituminous Recycler Machine, Bituminous Spreader and Mixer, Blacktop Plant (Non-Automated), Blast or Rotary Drill (Truck or Tractor Mounted), Brokk, Boring Machine, Cage Hoist, Central Mix Plant [(Non-Automated) and All Concrete Batching Plants], Concrete Paver (Over 16S), Crawler Drill (Self-contained), Crusher, Diesel Power Unit, Drill Rigs, Tractor Mounted, Front End Loader (Under 4 cu. yd.), Greaseman/Lubrication Engineer, Hi Pressure Boiler (15 lbs. and over), Hoist (One Drum), Hydro-Axe, Kolman Plant Loader and Similar Type Loaders (If Employer requires another man to clean the screen or to maintain the equipment, he shall be an Oiler), L.C.M. Work Boat Operator, Locomotive, Material handling knuckle boom, Mini Excavator (under 18,000 lbs.), Mixer (for stabilized base self-propelled), Monorail Machine, Plant Engineer, Prentice Loader, Profiler/Milling Machine (105 H.P. and under), Pug Mill, Pump Crete, Ready Mix Concrete Plant, Refrigeration Equipment (for soil stabilization), Road Widener, Roller (all above subgrade), Sea Mule, Self-contained Ride-on Rock Drill(Excluding Air-Track Type Drill), Skidder, Tractor with Dozer and/or Pusher, Trencher, Tugger Hoist, Vacuum machine (mounted or towed), Vermeer saw (ride on, any size or type), Welder, Winch, Winch Cat

**CLASSIFICATION C:**

A Frame Winch Hoist on Truck, Articulated Heavy Hauler, Aggregate Plant, Asphalt or Concrete Grooving Machine (ride on), Ballast Regulator(Ride-on), Boiler (used in conjunction with production), Bituminous Heater (self-propelled), Boat (powered), Cement and Bin Operator, Concrete Pavement Spreader and Finisher Concrete Paver or Mixer (16' and under), Concrete Saw (self-propelled), Conveyor, Deck Hand, Directional Drill Machine Locator, Drill (Core and Well), Farm Tractor with accessories, Fine Grade Machine, Fireman, Fork Lift, Form Tamper, Grout Pump, Gunit Machine, Hammers (Hydraulic self-propelled), Hydra-Spiker (ride-on), Hydraulic Pump (jacking system), Hydro-Blaster (Water), Mulching Machine, Oiler, Parapet Concrete or Pavement Grinder, Post Hole Digger and Post Driver, Power Broom (towed), Power Heaterman, Power Sweeper, Revinus Widener, Roller (Grade and Fill), Scarifier (ride-on), Shell Winder, Skid steer loader (Bobcat or similar; including all attachments), Span-Saw (ride-on), Steam Cleaner, Tamper (ride-on), Tie Extractor (ride-on), Tie Handler (ride-on), Tie Inserter (ride-on), Tie Spacer (ride-on), Tire Repair, Track Liner (ride-on), Tractor, Tractor (with towed accessories), Vibratory Compactor, Vibro Tamp, Well Point, and the following hands-off equipment: Compressors, Dust Collectors, Generators, Pumps, Welding Machines, Light Plants and Heaters

WAGES per hour	07/01/2024	07/01/2025
Class A1*	\$ 57.90	\$ 60.30
Class A	54.90	57.30
Class B	53.99	56.39
Class C	51.42	53.82

**(\*) TONNAGE RATING PREMIUMS:**

- Cranes over 1000 tons, A1 rate plus \$7.00
  - Cranes from 800-999 tons, A1 rate plus \$6.00
  - Cranes from 600-799 tons, A1 rate plus \$5.00
  - Cranes from 400-599 tons, A1 rate plus \$4.00
  - Cranes from 200-399 tons, A1 rate plus \$3.00
  - Cranes from 111-199 tons, A1 rate plus \$2.00
  - Cranes from 65-110 tons, A1 rate plus \$1.50
  - Cranes from 0-64 Tons, A1 rate only
- NOTE: Additional value subject to same premiums as shown for OT

- (\*\*) Tower Cranes, A1 rate plus \$3.00 (no tonnage premiums apply)**
- Cranes in Luffer Configuration, A1 rate plus \$5.00
  - Cranes with external ballast (tray or wagon), A1 rate plus \$5.00
- NOTE: Additional value subject to same premiums as shown for OT

Additional \$2.50 per hr. for hazardous waste removal work on State and/or Federally designated waste site which require employees to wear Level C or above forms of personal protection.

**SHIFT WORK**

Additional \$2.50 per hour for All Employees who work a single irregular work shift, of at least 5 consecutive days, starting from 5:00 PM to 1:00 AM that is mandated by the Contracting Agency.

**SUPPLEMENTAL BENEFITS**

Per hour	07/01/2024	07/01/2025
Journeyworker	\$ 32.60	\$ 33.70

**OVERTIME PAY**

See (B, E, Q) on OVERTIME PAGE

**HOLIDAY**

Paid: See (5, 6) on HOLIDAY PAGE  
 Overtime: See (5, 6) on HOLIDAY PAGE

Note: If the holiday falls on Sunday, it will be observed on Monday. If the observed Monday Holiday is worked, pay shall be double time plus Holiday pay for time worked. If the Holiday falls on a Saturday and is worked pay shall be double time plus Holiday pay for time worked. If the Holiday falls on a Saturday employer can choose to observe the paid holiday Saturday or give Friday off with holiday pay.

**REGISTERED APPRENTICES**

Wages per hour

1000 hours terms at the following percentage of Journeyworker's wage Class B

1st	2nd	3rd	4th
60%	70%	80%	90%

Supplemental Benefits per hour worked	07/01/2024	07/01/2025
All Terms	\$ 27.45	\$ 28.30

1-158H/H Alb

**Operating Engineer - Marine Dredging**

**02/01/2025**

**JOB DESCRIPTION** Operating Engineer - Marine Dredging

**DISTRICT 4**

**ENTIRE COUNTIES**

Albany, Bronx, Cayuga, Clinton, Columbia, Dutchess, Essex, Franklin, Greene, Jefferson, Kings, Monroe, Nassau, New York, Orange, Oswego, Putnam, Queens, Rensselaer, Richmond, Rockland, St. Lawrence, Suffolk, Ulster, Washington, Wayne, Westchester

**WAGES**

These wages do not apply to Operating Engineers on land based construction projects. For those projects, please see the Operating Engineer Heavy/Highway Rates. The wage rates below for all equipment and operators are only for marine dredging work in navigable waters found in the counties listed above.

Per Hour:	07/01/2024
CLASS A1 Deck Captain, Leverman, Mechanical Dredge Operator, Licensed Tug Operator 1000HP or more.	\$ 45.26
CLASS A2 Crane Operator (360 swing)	40.33
CLASS B Dozer, Front Loader Operator on Land	To conform to Operating Engineer Prevailing Wage in locality where work is being performed including benefits.
CLASS B1 Derrick Operator (180 swing) Spider/Spill Barge Operator Operator II, Fill Placer, Engineer Chief Mate, Electrician, Chief Welder, Maintenance Engineer, Licensed Boat, Crew Boat Operator	39.14
CLASS B2 Certified Welder	36.84
CLASS C1 Drag Barge Operator, Steward, Mate, Assistant Fill Placer	35.83
CLASS C2 Boat Operator	34.68
CLASS D Shoreman, Deckhand, Oiler, Rodman, Scowman, Cook, Messman, Porter/Janitor	28.81

**SUPPLEMENTAL BENEFITS**

Per Hour:  
 THE FOLLOWING SUPPLEMENTAL BENEFITS APPLY TO ALL CATEGORIES

All Classes A & B	\$ 12.00 plus 7% of straight time wage, Overtime hours add \$ 0.63
All Class C & D	\$ 11.75 plus 7% of straight time wage, Overtime hours add \$ 0.50

**OVERTIME PAY**  
 See (B2, F, R) on OVERTIME PAGE

**HOLIDAY**  
 Paid: See (1) on HOLIDAY PAGE  
 Overtime: See (5, 6, 8, 15, 26) on HOLIDAY PAGE

4-25a-MarDredge

---

**Operating Engineer - Survey Crew** **02/01/2025**

**JOB DESCRIPTION** Operating Engineer - Survey Crew **DISTRICT 12**

**ENTIRE COUNTIES**  
 Albany, Allegany, Broome, Cayuga, Chemung, Chenango, Clinton, Columbia, Cortland, Essex, Franklin, Fulton, Greene, Hamilton,  
 Herkimer, Jefferson, Lewis, Livingston, Madison, Monroe, Montgomery, Oneida, Onondaga, Ontario, Oswego, Otsego, Rensselaer,  
 Saratoga, Schenectady, Schoharie, Schuyler, Seneca, St. Lawrence, Steuben, Tioga, Tompkins, Warren, Washington, Wayne, Yates

**PARTIAL COUNTIES**  
 Dutchess: The northern portion of the county from the northern boundary line of the City of Poughkeepsie, north.

Genesee: Only the portion of the county that lies east of a line down the center of Route 98 to include all area that lies within the City of Batavia.

**WAGES**

These rates apply to Building, Tunnel and Heavy Highway.

Per hour:

**SURVEY CLASSIFICATIONS:**

- Party Chief - One who directs a survey party.
- Instrument Person - One who operates the surveying instruments.
- Rod Person - One who holds the rods and assists the Instrument Person.

07/01/2024

Party Chief	\$ 50.65
Instrument Person	46.54
Rod Person	34.55
Additional \$3.00/hr. for Tunnel Work	
Additional \$2.50/hr. for Hazardous Work Site	

**SUPPLEMENTAL BENEFITS**

Per hour worked:

Journeyman	\$ 29.75
------------	----------

**OVERTIME PAY**

See (B, E, P, \*X) on OVERTIME PAGE

\*Note: \$25.10/Hr. Only for "ALL" premium hours paid when worked.

**HOLIDAY**

Paid: See (5, 6) on HOLIDAY PAGE  
 Overtime: See (5, 6) on HOLIDAY PAGE

**REGISTERED APPRENTICES**

WAGES: 1000 hour terms based on the Percentage of Rod Persons Wage:

07/01/2024

0-1000	60%
1001-2000	70%
2001-3000	80%

SUPPLEMENTAL BENEFIT per hour worked:

0-1000	\$ 21.53 / PHP \$18.45
1001-2000	24.55 / " 20.45
2001-3000	27.58/ " 22.93

NOTE: PHP is premium hours paid when worked.

12-158-545 D.H.H.

**Operating Engineer - Survey Crew - Consulting Engineer**

**02/01/2025**

**JOB DESCRIPTION** Operating Engineer - Survey Crew - Consulting Engineer

**DISTRICT** 12

**ENTIRE COUNTIES**

Albany, Allegany, Broome, Cayuga, Chemung, Chenango, Clinton, Columbia, Cortland, Essex, Franklin, Fulton, Greene, Hamilton, Herkimer, Jefferson, Lewis, Livingston, Madison, Monroe, Montgomery, Oneida, Onondaga, Ontario, Oswego, Otsego, Rensselaer, Saratoga, Schenectady, Schoharie, Schuyler, Seneca, St. Lawrence, Steuben, Tioga, Tompkins, Warren, Washington, Wayne, Yates

**PARTIAL COUNTIES**

Dutchess: The northern portion of the county from the northern boundary line of the City of Poughkeepsie, north.  
 Genesee: Only the portion of the county that lies east of a line down the center of Route 98 to include all area that lies within the City of Batavia.

**WAGES**

These rates apply to feasibility and preliminary design surveying, line and grade surveying for inspection or supervision of construction when performed under a Consulting Engineer Agreement.

Per hour:

**SURVEY CLASSIFICATIONS:**

- Party Chief - One who directs a survey party.
- Instrument Person - One who operates the surveying instruments.

Rod Person - One who holds the rods and assists the Instrument Person.

07/01/2024

Party Chief	\$ 50.65
Instrument Person	46.54
Rod Person	34.55

Additional \$3.00/hr. for Tunnel Work.

Additional \$2.50/hr. for EPA or DEC certified toxic or hazardous waste work.

**SUPPLEMENTAL BENEFITS**

Per hour worked:

Journeyman	\$ 29.75
------------	----------

**OVERTIME PAY**

See (B, E, Q, \*X) on OVERTIME PAGE

\*Note: \$25.10/Hr. Only for "ALL" premium hours paid when worked.

**HOLIDAY**

Paid: See (1) on HOLIDAY PAGE  
Overtime: See (5, 6) on HOLIDAY PAGE

**REGISTERED APPRENTICES**

WAGES: 1000 hour terms based on percentage of Rod Persons Wage:

07/01/2024

0-1000	60%
1001-2000	70%
2001-3000	80%

SUPPLEMENTAL BENEFIT per hour worked:

0-1000	\$ 21.53 / PHP \$18.45
1001-2000	\$ 24.55 / " 20.45
2001-3000	\$ 26.98 / " 22.93

NOTE: PHP is premium hours paid when worked.

12-158-545 DCE

---

**Operating Engineer - Tunnel**

**02/01/2025**

**DISTRICT 7**

**JOB DESCRIPTION** Operating Engineer - Tunnel

**ENTIRE COUNTIES**

Albany, Allegany, Broome, Cayuga, Chemung, Chenango, Clinton, Columbia, Cortland, Essex, Franklin, Fulton, Greene, Hamilton, Herkimer, Jefferson, Lewis, Livingston, Madison, Monroe, Montgomery, Oneida, Onondaga, Ontario, Oswego, Otsego, Rensselaer, Saratoga, Schenectady, Schoharie, Schuyler, Seneca, St. Lawrence, Steuben, Tioga, Tompkins, Warren, Washington, Wayne, Yates

**PARTIAL COUNTIES**

Dutchess: Northern part of Dutchess, to the northern boundary line of the City of Poughkeepie, then due east to Route 115 to Bedell Road, then east along Bedell Road to VanWagner Road, then north along VanWagner Road to Bower Road, then east along Bower Road to Rte. 44 east to Rte. 343, then along Rte. 343 east to the northern boundary of the Town of Dover Plains and east along the northern boundary of the Town of Dover Plains, to the borderline of the State of Connecticut.

Genesee: Only that portion of the county that lies east of a line drawn down the center of Route 98 and the entirety of the City of Batavia.

**WAGES**

CLASS A: Automatic Concrete Spreader (CMI Type); Automatic Fine Grader; Backhoe (except tractor mounted, rubber tired); Belt Placer (CMI Type); Blacktop Plant (automated); Cableway; Caisson Auger; Central Mix Concrete Plant (automated); Concrete Curb Machine (self-propelled slipform); Concrete Pump (8" or over); Dredge; Dual Drum Paver; Excavator; Front End Loader (4 cu. yd & over); Gradall; Head Tower (Sauerman or Equal); Hoist (shaft); Hoist (two or three Drum); Log Chipper/Loader (self-feeder); Maintenance Engineer (shaft and tunnel); any Mechanical Shaft Drill; Mine Hoist; Mining Machine(Mole and similar types); Mucking Machine or Mole; Overhead Crane (Gantry or Straddle Type); Pile Driver; Power Grader; Remote Controlled Mole or Tunnel Machine; Scraper; Shovel; Side Boom; Slip Form Paver (If a second man is needed, they shall be an Oiler); Tripper/Maintenance Engineer (shaft & tunnel); Tractor Drawn Belt-Type Loader; Tug Operator (manned rented equipment excluded); Tunnel Shovel.

**CLASS B:** Automated Central Mix Concrete Plant; Backhoe (topside); Backhoe (track mounted, rubber tired); Backhoe (topside); Bituminous Spreader and Mixer, Blacktop Plant (non-automated); Blast or Rotary Drill (truck or tractor mounted); Boring Machine; Cage Hoist; Central Mix Plant(non-automated); all Concrete Batching Plants; Compressors (4 or less exceeding 2,000 c.f.m. combined capacity); Concrete Pump; Crusher; Diesel Power Unit; Drill Rigs (tractor mounted); Front End Loader (under 4 cu. yd.); Grayco Epoxy Machine; Hoist (One Drum); Hoist (2 or 3 drum topside); Knuckle Boom material handler; Kolman Plant Loader & similar type Loaders (if employer requires another person to clean the screen or to maintain the equipment, they shall be an Oiler); L.C.M. Work Boat Operator; Locomotive; Maintenance Engineer (topside); Maintenance Grease Man; Mixer (for stabilized base-self-propelled); Monorail Machine; Plant Engineer; Personnel Hoist; Pump Crete; Ready Mix Concrete Plant; Refrigeration Equipment (for soil stabilization); Road Widener; Roller (all above sub-grade); Sea Mule; Shotcrete Machine; Shovel (topside); Tractor with Dozer and/or Pusher; Trencher; Tugger Hoist; Tunnel Locomotive; Vacuum Machine (mounted or towed); Welder; Winch; Winch Cat.

**CLASS C:** A Frame Truck; All Terrain Telescoping Material Handler; Ballast Regulator (ride-on); Compressors (4 not to exceed 2,000 c.f.m. combined capacity; or 3 or less with more than 1200 c.f.m. but not to exceed 2,000 c.f.m.); Compressors ((any size, but subject to other provisions for compressors), Dust Collectors, Generators, Pumps, Welding Machines, Light Plants (4 or any type combination)); Concrete Pavement Spreaders and Finishers; Conveyor; Drill (core); Drill (well); Electric Pump used in conjunction with Well Point System; Farm Tractor with Accessories; Fine Grade Machine; Fork Lift; Grout Pump (over 5 cu. ft.); Gunite Machine; Hammers (hydraulic-self-propelled); Hydra-Spiker (ride-on); Hydra-Blaster (water); Hydro-Blaster; Motorized Form Carrier; Post Hole Digger and Post Driver; Power Sweeper; Roller grade & fill); Scarifer (ride-on); Span-Saw (ride-on); Submersible Electric Pump (when used in lieu of well points); Tamper (ride-on); Tie-Extractor (ride-on), Tie Handler (ride-on), Tie Inserter (ride-on), Tie Spacer (ride-on); Track Liner (ride-on); Tractor with towed accessories; Vibratory Compactor; Vibro Tamp, Well Point.

**CLASS D:** Aggregate Plant; Cement & Bin Operator; Compressors (3 or less not to exceed 1,200 c.f.m. combined capacity); Compressors ((any size, but subject to other provisions for compressors), Dust Collectors, Generators, Pumps, Welding Machines, Light Plants (3 or less or any type or combination)); Concrete Saw (self-propelled); Form Tamper; Greaseman; Hydraulic Pump (jacking system); Junior Engineer; Light Plants; Mulching Machine; Oiler; Parapet Concrete or Pavement Grinder; Power Broom (towed); Power Heaterman (when used for production); Revinius Widener; Shell Winder; Steam Cleaner; Tractor.

Per hour:	07/01/2024	07/01/2025
CLASS A	\$ 55.91	\$ 58.44
CLASS B	54.69	57.22
CLASS C	51.90	54.43
CLASS D	48.89	51.42

Additional \$5.00 per hour for Hazardous Waste Work on a state or federally designated hazardous waste site where the Operating Engineer is in direct contact with hazardous material and when personal protective equipment is required for respiratory, skin and eye protection.

**CRANES:**

- Crane 1: All cranes, including self-erecting.
- Crane 2: All Lattice Boom Cranes and all cranes with a manufacturer's rating of fifty (50) ton and over.
- Crane 3: All hydraulic cranes and derricks with a manufacturer's rating of forty nine (49) ton and below, including boom trucks.

Crane 1	\$ 59.91	\$ 62.44
Crane 2	58.91	61.44
Crane 3	57.91	60.44

**SUPPLEMENTAL BENEFITS**

Per hour:		
	\$ 25.05	\$ 25.90
	+ 9.85*	+ 10.10*

\* This portion of benefits subject to same premium rate as shown for overtime wages.

**OVERTIME PAY**

See (B, B2, E, Q, X) on OVERTIME PAGE

**HOLIDAY**

Paid: See (5, 6) on HOLIDAY PAGE  
 Overtime: See (5, 6) on HOLIDAY PAGE

NOTE: If a holiday falls on Sunday, it shall be observed on Monday.

**REGISTERED APPRENTICES**

WAGES:(1000) hours terms at the following percentage of Journeyworker's Class B wage.

1st term	60%
2nd term	65%
3rd term	70%
4th term	75%

SUPPLEMENTAL BENEFITS per hour: Same as Journeyworker

**Painter**

**02/01/2025**

**JOB DESCRIPTION** Painter

**DISTRICT 1**

**ENTIRE COUNTIES**

Albany, Clinton, Essex, Franklin, Fulton, Hamilton, Montgomery, Rensselaer, Saratoga, Schenectady, Schoharie, Warren, Washington

**WAGES**

Per hour

07/01/2024

Painter\Wallcovers	\$ 32.03**
Drywall Finishers	32.03**
Spray Rate	32.03**
Structural Steel*	33.03**
Lead Abatement	33.03**
Lead Abatement on Structural Steel	34.03**

(\* )Employees working on objects with the use of swing stage, boatswain chair, pick and cables only will be paid at Structural Steel rate.

(\*\* ) Plus Additional \$1.25 per hour not subject to Overtime/Premiums

Bridge Painter

See Bridge Painter rates for the following work:

All Bridges and Tanks

**SHIFT WORK**

THE FOLLOWING ADDITIONAL HOURLY RATE WILL APPLY ON ALL CONTRACTING AGENCY MANDATED SHIFT(S) OR SINGULAR IRREGULAR SHIFT WHEN THE SHIFT STARTS BETWEEN THE HOURS LISTED BELOW:

2:30 PM to 6:00 AM PLUS \$1.00 to the applicable rate,  
and this is not subject to overtime

**SUPPLEMENTAL BENEFITS**

Per hour

Journeyworker \$ 20.51

**OVERTIME PAY**

See (B, E2, H) on OVERTIME PAGE

**HOLIDAY**

Paid: See (1) on HOLIDAY PAGE

Overtime: See (5, 6) on HOLIDAY PAGE

Note: If the holiday falls on Sunday, it shall be observed on Monday.

**REGISTERED APPRENTICES**

Wages per hour

1000 hour terms at the following percentage of Journeyworker's base wage

Apprentice rate is calculated on the rate before the \$1.25 is added, then add the \$1.25

1st	2nd	3rd	4th	5th	6th
\$15	50%	60%	70%	80%	90%

Supplemental Benefits per hour

All Terms \$ 20.51

1-201-P

**Painter - Bridge & Structural Steel**

**02/01/2025**

**JOB DESCRIPTION** Painter - Bridge & Structural Steel

**DISTRICT 8**

**ENTIRE COUNTIES**

Albany, Bronx, Clinton, Columbia, Dutchess, Essex, Franklin, Fulton, Greene, Hamilton, Kings, Montgomery, Nassau, New York, Orange, Putnam, Queens, Rensselaer, Richmond, Rockland, Saratoga, Schenectady, Schoharie, Suffolk, Sullivan, Ulster, Warren, Washington, Westchester

**WAGES**

Per Hour:

STEEL:

Bridge Painting: 07/01/2024

\$ 56.00

+ 10.35\*

ADDITIONAL \$7.00 per hour for POWER TOOL/SPRAY, whether straight time or overtime.

NOTE: All premium wages are to be calculated on base rate per hour only.

\* For the period of May 1st to November 15th, this amount is payable up to 40 hours. For the period of Nov 16th to April 30th, this amount is payable up to 50 hours. EXCEPTION: First and last week of employment, and for the weeks of Memorial Day, Independence Day and Labor Day, where the amount is paid for the actual number of hours worked (50 hour cap).

NOTE: Generally, for Bridge Painting Contracts, ALL WORKERS on and off the bridge (including Flagmen) are to be paid Painter's Rate; the contract must be ONLY for Bridge Painting.

**SHIFT WORK**

When directly specified in public agency or authority contract documents for an employer to work a second shift and works the second shift with employees other than from the first shift, all employees who work the second shift will be paid 10% of the base wage shift differential in lieu of overtime for the first eight (8) hours worked after which the employees shall be paid at time and one half of the regular wage rate. When a single irregular work shift is mandated in the job specifications or by the contracting agency, wages shall be paid at time and one half for single shifts between the hours of 3pm-11pm or 11pm-7am.

**SUPPLEMENTAL BENEFITS**

Per Hour:

Journeyworker:

\$ 12.43  
+ 31.55\*

\* For the period of May 1st to November 15th, this amount is payable up to 40 hours. For the period of Nov 16th to April 30th, this amount is payable up to 50 hours. EXCEPTION: First and last week of employment, and for the weeks of Memorial Day, Independence Day and Labor Day, where the amount is paid for the actual number of hours worked (50 hour cap).

**OVERTIME PAY**

See (B, F, R) on OVERTIME PAGE

**HOLIDAY**

Paid:

See (1) on HOLIDAY PAGE

Overtime:

See (4, 6) on HOLIDAY PAGE

**REGISTERED APPRENTICES**

Wage - Per hour:

Apprentices: (1) year terms.

1st year \$ 22.40  
+ 4.14

2nd year \$ 33.60  
+ 6.21

3rd year \$ 44.80  
+ 8.28

Supplemental Benefits - Per hour:

1st year \$ 1.16  
+ 12.62

2nd year \$ 7.46  
+ 18.93

3rd year \$ 9.94  
+ 25.24

NOTE: All premium wages are to be calculated on base rate per hour only.

8-DC-9/806/155-BrSS

**Painter - Line Striping**

02/01/2025

**JOB DESCRIPTION** Painter - Line Striping

**DISTRICT 8**

**ENTIRE COUNTIES**

Albany, Clinton, Columbia, Dutchess, Essex, Franklin, Fulton, Greene, Hamilton, Montgomery, Nassau, Orange, Putnam, Rensselaer, Rockland, Saratoga, Schenectady, Schoharie, Suffolk, Sullivan, Ulster, Warren, Washington, Westchester

**WAGES**

Per hour:



	07/01/2024	04/01/2025	04/01/2026
Painter (Striping-Highway):			
Striping-Machine Operator*	\$ 34.12	\$ 35.49	\$ 36.93
Linerman Thermoplastic	41.12	42.74	44.44

Note: \* Includes but is not limited to: Positioning of cones and directing of traffic using hand held devices. Excludes the Driver/Operator of equipment used in the maintenance and protection of traffic safety.

**SHIFT WORK**

When directly specified in public agency or authority contract documents there shall be a 30% night shift premium pay differential for all work performed after 9:00pm and before 5:00am.

**SUPPLEMENTAL BENEFITS**

Per hour paid:

Journeyworker:			
Striping Machine Operator:	\$23.65	\$ 24.30	\$ 24.95
Linerman Thermoplastic:	23.65	24.30	24.95

**OVERTIME PAY**

See (B, B2, E2, F, S) on OVERTIME PAGE

**HOLIDAY**

Paid: See (5, 20) on HOLIDAY PAGE  
 Overtime: See (5, 20) on HOLIDAY PAGE

**REGISTERED APPRENTICES**

One (1) year terms at the following wage rates:

	07/01/2024	01/01/2025	04/01/2025	04/01/2026
1st Term:	\$ 16.00	\$ 16.50	\$ 16.50	\$ 16.50
2nd Term:	20.47	20.47	21.29	22.16
3rd Term:	27.30	27.30	28.39	29.54
Supplemental Benefits per hour:				
All terms:	\$ 23.65	\$ 23.65	\$ 24.30	\$ 24.95

8-1456-LS

**Painter - Metal Polisher**

**02/01/2025**

**JOB DESCRIPTION** Painter - Metal Polisher

**DISTRICT 8**

**ENTIRE COUNTIES**

Albany, Allegany, Bronx, Broome, Cattaraugus, Cayuga, Chautauqua, Chemung, Chenango, Clinton, Columbia, Cortland, Delaware, Dutchess, Erie, Essex, Franklin, Fulton, Genesee, Greene, Hamilton, Herkimer, Jefferson, Kings, Lewis, Livingston, Madison, Monroe, Montgomery, Nassau, New York, Niagara, Oneida, Onondaga, Ontario, Orange, Orleans, Oswego, Otsego, Putnam, Queens, Rensselaer, Richmond, Rockland, Saratoga, Schenectady, Schoharie, Schuylar, Seneca, St. Lawrence, Steuben, Suffolk, Sullivan, Tioga, Tompkins, Ulster, Warren, Washington, Wayne, Westchester, Wyoming, Yates

**WAGES**

	07/01/2024
Metal Polisher	\$ 39.33
Metal Polisher*	40.43
Metal Polisher**	43.33

\*Note: Applies on New Construction & complete renovation

\*\* Note: Applies when working on scaffolds over 34 feet.

**SUPPLEMENTAL BENEFITS**

Per Hour: 07/01/2024

Journeyworker:	
All classification	\$ 12.79

**OVERTIME PAY**

See (B, E, P, T) on OVERTIME PAGE

**HOLIDAY**

Paid: See (5, 6, 11, 15, 16, 25, 26) on HOLIDAY PAGE  
 Overtime: See (5, 6, 11, 15, 16, 25, 26) on HOLIDAY PAGE

**REGISTERED APPRENTICES**

Wages per hour:  
 One (1) year term at the following wage rates:

	07/01/2024
1st year	\$ 19.67
2nd year	21.63
3rd year	23.60
1st year*	\$ 22.06
2nd year*	22.07
3rd year*	24.14
1st year**	\$ 22.17
2nd year**	24.13
3rd year**	26.10

\*Note: Applies on New Construction & complete renovation

\*\* Note: Applies when working on scaffolds over 34 feet.

Supplemental benefits:

Per hour:

1st year	\$ 8.69
2nd year	8.69
3rd year	8.69

8-8A/28A-MP

**Plumber**

**02/01/2025**

**JOB DESCRIPTION** Plumber

**DISTRICT 1**

**ENTIRE COUNTIES**

Essex

**PARTIAL COUNTIES**

Franklin: Entire County except for the Village of Hogansburg and the St. Regis Indian Reservation.

Hamilton: The Townships of Long Lake and Indian Lake

**WAGES**

Per hour

07/01/2024

Plumber & Steamfitter	\$ 44.28
--------------------------	----------

**SUPPLEMENTAL BENEFITS**

Per hour

Journeyworker	\$ 22.20 +11.20*
---------------	---------------------

\* This portion of the benefit is subject to the SAME PREMIUM as shown for overtime and applicable to paid Holidays.

**OVERTIME PAY**

See (B, E, Q) on OVERTIME PAGE

**HOLIDAY**

Paid: See (22) on HOLIDAY PAGE

Overtime: See (5, 6, 23) on HOLIDAY PAGE

Note: For the paid Christmas Holiday the employee must have worked 20 regular working days in the calendar year with contractor to qualify

Note: Whenever a Holiday falls on a Saturday, the preceding day, Friday, shall be observed as the Holiday. If a Holiday falls on a Sunday, the following day, Monday shall be observed as the Holiday.

**REGISTERED APPRENTICES**

Wages per hour

One year terms at the following percentage of Journeyperson's wage

1st yr	50%
2nd yr	60%
3rd yr	70%
4th yr	80%

5th yr 90%

Supplemental Benefits per hour worked

1st yr \$ 19.03 + 5.60\*  
 2nd yr 19.66 + 6.72\*  
 3rd yr 20.30 + 7.84\*  
 4th yr 20.93 + 8.96\*  
 5th yr 21.57 + 10.08\*

\* This portion of the benefit is subject to the SAME PREMIUM as shown for overtime.  
 \* This portion per hour paid.

1-773EF-SF

**Roofer**

**02/01/2025**

**JOB DESCRIPTION** Roofer

**DISTRICT 1**

**ENTIRE COUNTIES**

Albany, Clinton, Columbia, Essex, Fulton, Greene, Hamilton, Montgomery, Rensselaer, Saratoga, Schenectady, Warren, Washington

**WAGES**

Per hour	07/01/2024	07/01/2025 Additional
Roofer/Waterproofer	\$ 37.05	\$ 1.75*
Asphalt Cold Process	37.55	
Fluid Applied Roof	37.55	
Pitch & Asbestos	39.05	

(\* ) To be allocated at a later date

**SHIFT WORK**

Shift Work:  
 On government mandated shift work starting after 12:00pm and before 4:00am workers shall be paid \$4.00 additional per hour

**SUPPLEMENTAL BENEFITS**

Per hour  
 Journeyworker \$ 23.52

**OVERTIME PAY**

See (B, E, J) on OVERTIME PAGE.

**HOLIDAY**

Paid: See (1) on HOLIDAY PAGE  
 Overtime: See (5, 6) on HOLIDAY PAGE

Note: When any Holiday falls on Saturday, the Friday before such Holiday shall be recognized as the legal Holiday. When a Holiday falls on Sunday, it shall be observed the following Monday.

**REGISTERED APPRENTICES**

Wages per hour

Apprentice terms at the following per cent of the Roofer/Waterproofer rate. For Pitch & Asbestos work, an additional \$2.00 must be paid in wages. For Asphalt Cold Process work and Fluid Applied Roof coating, an additional \$0.50 must be paid in the wages.

1st Term 58% + \$ 3.00  
 1500 hrs.

2nd Term 74% + \$ 3.00  
 1 yr. and 1500 hrs. as 1st term.

3rd Term 90%  
 1 yr. and 1500 hrs. as 2nd term.

3rd Term complete at 1 yr and 1050 hrs. as 3rd term

Supplemental Benefits per hour worked

1st Term \$ 18.94

2nd Term	19.37
3rd Term	22.85

1-241

**Sheetmetal Worker**

02/01/2025

**JOB DESCRIPTION** Sheetmetal Worker

**DISTRICT 1**

**ENTIRE COUNTIES**

Albany, Clinton, Columbia, Essex, Franklin, Fulton, Greene, Hamilton, Montgomery, Rensselaer, Saratoga, Schenectady, Schoharie, Warren, Washington

**WAGES**

Per hour 07/01/2024

Sheetmetal Worker \$ 40.52

All work requiring HAZWOPER Training additional \$1.00 per hour.

**SUPPLEMENTAL BENEFITS**

Per hour

Journeyworker \$ 37.27

**OVERTIME PAY**

See ( B,E,E5,Q ) on OVERTIME PAGE

**HOLIDAY**

Paid: See (1) on HOLIDAY PAGE  
 Overtime: See (5, 6) on HOLIDAY PAGE

When any holiday falls on Saturday, the Friday before such holiday shall be recognized as the legal holiday. Any holiday falling on Sunday, the following Monday shall be recognized as the legal holiday.

**REGISTERED APPRENTICES**

Wages per hour

6 Month Terms at the following rate:

1st term	\$ 22.71
2nd term	24.57
3rd term	25.49
4th term	26.42
5th term	25.12
6th term	26.34
7th term	28.36
8th term	30.39
9th term	32.42
10th term	34.44

Supplemental Benefits per hour

1st term	\$ 23.21
2nd term	23.82
3rd term	24.13
4th term	24.58
5th term	31.59
6th term	32.04
7th term	32.79
8th term	33.56
9th term	34.32
10th term	35.07

1-83

**Sprinkler Fitter**

02/01/2025

**JOB DESCRIPTION** Sprinkler Fitter

**DISTRICT 1**

**ENTIRE COUNTIES**

Allegany, Broome, Cattaraugus, Cayuga, Chautauqua, Chemung, Chenango, Clinton, Columbia, Cortland, Delaware, Erie, Essex, Franklin, Fulton, Genesee, Greene, Hamilton, Herkimer, Jefferson, Lewis, Livingston, Madison, Monroe, Montgomery, Niagara, Oneida, Onondaga, Ontario, Orleans, Oswego, Otsego, Schoharie, Schuyler, Seneca, St. Lawrence, Steuben, Tioga, Tompkins, Washington, Wayne, Wyoming, Yates

**WAGES**

Per hour 07/01/2024

Sprinkler \$ 42.00  
 Fitter

**SUPPLEMENTAL BENEFITS**

Per hour

Journeyworker \$ 28.82

**OVERTIME PAY**

See (B, E, Q) on OVERTIME PAGE

**HOLIDAY**

Paid: See (1) on HOLIDAY PAGE  
 Overtime: See (5, 6) on HOLIDAY PAGE

Note: When a holiday falls on Sunday, the following Monday shall be considered a holiday and all work performed on either day shall be at the double time rate. When a holiday falls on Saturday, the preceding Friday shall be considered a holiday and all work performed on either day shall be at the double time rate.

**REGISTERED APPRENTICES**

Wages per hour

One Half Year terms at the following wage.

1st	2nd	3rd	4th	5th	6th	7th	8th	9th	10th
\$ 20.03	\$ 22.26	\$ 24.24	\$ 26.46	\$ 28.69	\$ 30.91	\$ 33.14	\$ 35.37	\$ 37.59	\$ 39.82

Supplemental Benefits per hour

1st	2nd	3rd	4th	5th	6th	7th	8th	9th	10th
\$ 9.18	\$ 9.18	\$ 20.90	\$ 20.90	\$ 21.15	\$ 21.15	\$ 21.15	\$ 21.15	\$ 21.15	\$ 21.15 1-669

**Teamster - Building**

**02/01/2025**

**JOB DESCRIPTION** Teamster - Building

**DISTRICT 7**

**ENTIRE COUNTIES**

Clinton, Essex, Franklin, Jefferson, St. Lawrence

**PARTIAL COUNTIES**

Lewis: Only the Townships of Croghan, Denmark, Diana, New Bremen, Harrisburg, Montague, Osceola and Pinckney.  
 Oswego: Only the Towns of Boylston, Redfield, and Sandy Creek.  
 Warren: Only the Townships of Hague, Horicon, Chester and Johnsburg.

**WAGES**

GROUP #1: Fuel Trucks, Fork Lift\* (Warehouse Area Only), Warehouse\*, Yardman\*, Truck Helper, Pickups, Panel Truck, Flatbody Material Trucks (straight jobs), Single axle Dump Trucks, Dumpsters, Material Checkers/Receivers\*, Greasers, Tiremen, Mechanic Helpers/Parts Chasers, Bus.

GROUP #2: Tandems, Mechanics & Batch Trucks.

GROUP #3: Semi Trailers, Low Boys, Asphalt Distributor Trucks, and Agitator Mixer Truck, Dump Crete Type Vehicles and 3 axle Dump trucks.

GROUP #4: Asbestos Removal, Special earth moving Euclid type or similar off highway equip.(non self load.) Articulated and all-track dump trucks.

\*NOTE - Applies when a temporary warehouse structure is built/utilized specifically for a public work project.

Per hour: 07/01/2024

GROUP #1 \$ 30.72  
 GROUP #2 31.72  
 GROUP #3 31.82  
 GROUP #4 30.98

**SUPPLEMENTAL BENEFITS**

Per hour:

Journeyworker \$ 23.34

**OVERTIME PAY**

See (B, E, Q) on OVERTIME PAGE

**HOLIDAY**

Paid: See (1) on HOLIDAY PAGE  
Overtime: See (5, 6) on HOLIDAY PAGE

7-687B

---

**Teamster - Heavy&Highway**

**02/01/2025**

**JOB DESCRIPTION** Teamster - Heavy&Highway

**DISTRICT 7**

**ENTIRE COUNTIES**

Clinton, Essex, Franklin, Jefferson, St. Lawrence

**PARTIAL COUNTIES**

Lewis: Only the Townships of Croghan, Denmark, Diana, New Bremen, Harrisburg, Montague, Osceola and Pinckney.

Oswego: Only the Towns of Boylston, Redfield, and Sandy Creek.

Warren: Only the Townships of Hague, Horicon, Chester and Johnsburg.

**WAGES**

GROUP #1: Warehousemen\*, Yardmen\*, Truck Helpers, Pickups, Panel Trucks, Flatboy Material Trucks(straight jobs), Single Axle Dump Trucks, Dumpsters, Material Checkers/Receivers\*, Greasers, Truck Tiremen, Mechanics Helpers/Parts Chasers, Fork Lift\* (Warehouse Area Only), Tandems and Batch Trucks, Mechanics. Semi-Trailers, Low-Boy Trucks, Asphalt Distributor Trucks, and Agitator, Mixer Trucks and Dumpcrete type vehicles, Truck Mechanic, Fuel Truck.

GROUP #2: Specialized Earth Moving Equipment, Euclid type, or similar off-highway where not self-loading, Straddle (Ross) Carrier, and self-contained concrete mobile truck. Off-highway Tandem Back-Dump, Twin Engine Equipment and Double-Hitched Equipment where not self-loading.

\*NOTE - Applies when a temporary warehouse structure is built/utilized specifically for a public work project.

Per hour: 07/01/2024

GROUP #1 \$ 32.78

GROUP #2 33.00

Additional \$1.50 per hour for hazardous waste removal work on a City, County, State and/or Federal Designated waste site and regulations require employee to use or wear respiratory protection.

**SUPPLEMENTAL BENEFITS**

Per hour:

Journeyworker \$ 25.72

**OVERTIME PAY**

See (B, E, Q) on OVERTIME PAGE

**HOLIDAY**

Paid: See (1) on HOLIDAY PAGE

Overtime: See (5, 6) on HOLIDAY PAGE

NOTE: If a holiday falls on a Sunday, it will be celebrated on Monday.

7-687

---

**Welder**

**02/01/2025**

**JOB DESCRIPTION** Welder

**DISTRICT 1**

**ENTIRE COUNTIES**

Albany, Allegany, Bronx, Broome, Cattaraugus, Cayuga, Chautauqua, Chemung, Chenango, Clinton, Columbia, Cortland, Delaware, Dutchess, Erie, Essex, Franklin, Fulton, Genesee, Greene, Hamilton, Herkimer, Jefferson, Kings, Lewis, Livingston, Madison, Monroe, Montgomery, Nassau, New York, Niagara, Oneida, Onondaga, Ontario, Orange, Orleans, Oswego, Otsego, Putnam, Queens, Rensselaer, Richmond, Rockland, Saratoga, Schenectady, Schoharie, Schuyler, Seneca, St. Lawrence, Steuben, Suffolk, Sullivan, Tioga, Tompkins, Ulster, Warren, Washington, Wayne, Westchester, Wyoming, Yates

**WAGES**

Per hour 07/01/2024

Welder: To be paid the same rate of the mechanic performing the work.\*

\*EXCEPTION: If a specific welder certification is required, then the 'Certified Welder' rate in that trade tag will be paid.

**OVERTIME PAY**

**HOLIDAY**

1-As Per Trade

## Overtime Codes

Following is an explanation of the code(s) listed in the OVERTIME section of each classification contained in the attached schedule. Additional requirements may also be listed in the HOLIDAY section.

NOTE: Supplemental Benefits are 'Per hour worked' (for each hour worked) unless otherwise noted

- ( AA ) Time and one half of the hourly rate after 7 and one half hours per day
- ( A ) Time and one half of the hourly rate after 7 hours per day
- ( B ) Time and one half of the hourly rate after 8 hours per day
- ( B1 ) Time and one half of the hourly rate for the 9th & 10th hours week days and the 1st 8 hours on Saturday.  
Double the hourly rate for all additional hours
- ( B2 ) Time and one half of the hourly rate after 40 hours per week
- ( B3 ) Time and one half of the hourly rate after 40 straight hours per week
- ( C ) Double the hourly rate after 7 hours per day
- ( C1 ) Double the hourly rate after 7 and one half hours per day
- ( D ) Double the hourly rate after 8 hours per day
- ( D1 ) Double the hourly rate after 9 hours per day
- ( E ) Time and one half of the hourly rate on Saturday
- ( E1 ) Time and one half 1st 4 hours on Saturday; Double the hourly rate all additional Saturday hours
- ( E2 ) Saturday may be used as a make-up day at straight time when a day is lost during that week due to inclement weather
- ( E3 ) Between November 1st and March 3rd Saturday may be used as a make-up day at straight time when a day is lost during that week due to inclement weather, provided a given employee has worked between 16 and 32 hours that week
- ( E4 ) Saturday and Sunday may be used as a make-up day at straight time when a day is lost during that week due to inclement weather
- ( E5 ) Double time after 8 hours on Saturdays
- ( F ) Time and one half of the hourly rate on Saturday and Sunday
- ( G ) Time and one half of the hourly rate on Saturday and Holidays
- ( H ) Time and one half of the hourly rate on Saturday, Sunday, and Holidays
- ( I ) Time and one half of the hourly rate on Sunday
- ( J ) Time and one half of the hourly rate on Sunday and Holidays
- ( K ) Time and one half of the hourly rate on Holidays
- ( L ) Double the hourly rate on Saturday
- ( M ) Double the hourly rate on Saturday and Sunday
- ( N ) Double the hourly rate on Saturday and Holidays
- ( O ) Double the hourly rate on Saturday, Sunday, and Holidays
- ( P ) Double the hourly rate on Sunday
- ( Q ) Double the hourly rate on Sunday and Holidays
- ( R ) Double the hourly rate on Holidays

- ( S ) Two and one half times the hourly rate for Holidays
- ( S1 ) Two and one half times the hourly rate the first 8 hours on Sunday or Holidays One and one half times the hourly rate all additional hours.
- ( T ) Triple the hourly rate for Holidays
- ( U ) Four times the hourly rate for Holidays
- ( V ) Including benefits at SAME PREMIUM as shown for overtime
- ( W ) Time and one half for benefits on all overtime hours.
- ( X ) Benefits payable on Paid Holiday at straight time. If worked, additional benefit amount will be required for worked hours. (Refer to other codes listed.)



## Holiday Codes

### PAID Holidays:

Paid Holidays are days for which an eligible employee receives a regular day's pay, but is not required to perform work. If an employee works on a day listed as a paid holiday, this remuneration is in addition to payment of the required prevailing rate for the work actually performed.

### OVERTIME Holiday Pay:

Overtime holiday pay is the premium pay that is required for work performed on specified holidays. It is only required where the employee actually performs work on such holidays. The applicable holidays are listed under HOLIDAYS: OVERTIME. The required rate of pay for these covered holidays can be found in the OVERTIME PAY section listings for each classification.

Following is an explanation of the code(s) listed in the HOLIDAY section of each classification contained in the attached schedule. The Holidays as listed below are to be paid at the wage rates at which the employee is normally classified.

- ( 1 ) None
- ( 2 ) Labor Day
- ( 3 ) Memorial Day and Labor Day
- ( 4 ) Memorial Day and July 4th
- ( 5 ) Memorial Day, July 4th, and Labor Day
- ( 6 ) New Year's, Thanksgiving, and Christmas
- ( 7 ) Lincoln's Birthday, Washington's Birthday, and Veterans Day
- ( 8 ) Good Friday
- ( 9 ) Lincoln's Birthday
- ( 10 ) Washington's Birthday
- ( 11 ) Columbus Day
- ( 12 ) Election Day
- ( 13 ) Presidential Election Day
- ( 14 ) 1/2 Day on Presidential Election Day
- ( 15 ) Veterans Day
- ( 16 ) Day after Thanksgiving
- ( 17 ) July 4th
- ( 18 ) 1/2 Day before Christmas
- ( 19 ) 1/2 Day before New Years
- ( 20 ) Thanksgiving
- ( 21 ) New Year's Day
- ( 22 ) Christmas
- ( 23 ) Day before Christmas
- ( 24 ) Day before New Year's
- ( 25 ) Presidents' Day
- ( 26 ) Martin Luther King, Jr. Day
- ( 27 ) Memorial Day
- ( 28 ) Easter Sunday

( 29 )      Juneteenth

**New York State Department of Labor - Bureau of Public Work  
State Office Building Campus  
Building 12 - Room 130  
Albany, New York 12226**

**REQUEST FOR WAGE AND SUPPLEMENT INFORMATION**

As Required by Articles 8 and 9 of the NYS Labor Law

Fax (518) 485-1870 or mail this form for new schedules or for determination for additional occupations.

**This Form Must Be Typed**

Submitted By:

(Check Only One)

Contracting Agency     Architect or Engineering Firm     Public Work District Office    Date:

**A. Public Work Contract to be let by:** (Enter Data Pertaining to Contracting/Public Agency)

<p>1. Name and complete address <input type="checkbox"/> (Check if new or change)</p>  <p>Telephone _____ Fax _____</p> <p>E-Mail: _____</p>	<p>2. NY State Units (see Item 5).</p> <table style="width:100%;"> <tr> <td><input type="checkbox"/> 01 DOT</td> <td><input type="checkbox"/> 07 City</td> </tr> <tr> <td><input type="checkbox"/> 02 OGS</td> <td><input type="checkbox"/> 08 Local School District</td> </tr> <tr> <td><input type="checkbox"/> 03 Dormitory Authority</td> <td><input type="checkbox"/> 09 Special Local District, i.e., Fire, Sewer, Water District</td> </tr> <tr> <td><input type="checkbox"/> 04 State University Construction Fund</td> <td><input type="checkbox"/> 10 Village</td> </tr> <tr> <td><input type="checkbox"/> 05 Mental Hygiene Facilities Corp.</td> <td><input type="checkbox"/> 11 Town</td> </tr> <tr> <td><input type="checkbox"/> 06 OTHER N.Y. STATE UNIT</td> <td><input type="checkbox"/> 12 County</td> </tr> <tr> <td></td> <td><input type="checkbox"/> 13 Other Non-N.Y. State (Describe)</td> </tr> </table>	<input type="checkbox"/> 01 DOT	<input type="checkbox"/> 07 City	<input type="checkbox"/> 02 OGS	<input type="checkbox"/> 08 Local School District	<input type="checkbox"/> 03 Dormitory Authority	<input type="checkbox"/> 09 Special Local District, i.e., Fire, Sewer, Water District	<input type="checkbox"/> 04 State University Construction Fund	<input type="checkbox"/> 10 Village	<input type="checkbox"/> 05 Mental Hygiene Facilities Corp.	<input type="checkbox"/> 11 Town	<input type="checkbox"/> 06 OTHER N.Y. STATE UNIT	<input type="checkbox"/> 12 County		<input type="checkbox"/> 13 Other Non-N.Y. State (Describe)
<input type="checkbox"/> 01 DOT	<input type="checkbox"/> 07 City														
<input type="checkbox"/> 02 OGS	<input type="checkbox"/> 08 Local School District														
<input type="checkbox"/> 03 Dormitory Authority	<input type="checkbox"/> 09 Special Local District, i.e., Fire, Sewer, Water District														
<input type="checkbox"/> 04 State University Construction Fund	<input type="checkbox"/> 10 Village														
<input type="checkbox"/> 05 Mental Hygiene Facilities Corp.	<input type="checkbox"/> 11 Town														
<input type="checkbox"/> 06 OTHER N.Y. STATE UNIT	<input type="checkbox"/> 12 County														
	<input type="checkbox"/> 13 Other Non-N.Y. State (Describe)														

<p>3. SEND REPLY TO <input type="checkbox"/> (check if new or change) Name and complete address:</p>  <p>Telephone _____ Fax _____</p> <p>E-Mail: _____</p>	<p>4. SERVICE REQUIRED. Check appropriate box and provide project information.</p> <p><input type="checkbox"/> New Schedule of Wages and Supplements. APPROXIMATE BID DATE : _____</p> <p><input type="checkbox"/> Additional Occupation and/or Redetermination</p> <table border="1" style="width:100%; margin-top: 10px;"> <tr> <td style="width:70%;">PRC NUMBER ISSUED PREVIOUSLY FOR THIS PROJECT :</td> <td style="width:30%;">OFFICE USE ONLY</td> </tr> </table>	PRC NUMBER ISSUED PREVIOUSLY FOR THIS PROJECT :	OFFICE USE ONLY
PRC NUMBER ISSUED PREVIOUSLY FOR THIS PROJECT :	OFFICE USE ONLY		

**B. PROJECT PARTICULARS**

<p>5. Project Title _____</p> <p>Description of Work _____</p> <p>Contract Identification Number _____</p> <p>Note: For NYS units, the OSC Contract No. _____</p>	<p>6. Location of Project:</p> <p>Location on Site _____</p> <p>Route No/Street Address _____</p> <p>Village or City _____</p> <p>Town _____</p> <p>County _____</p>
---	--

<p>7. Nature of Project - Check One:</p> <p><input type="checkbox"/> 1. New Building</p> <p><input type="checkbox"/> 2. Addition to Existing Structure</p> <p><input type="checkbox"/> 3. Heavy and Highway Construction (New and Repair)</p> <p><input type="checkbox"/> 4. New Sewer or Waterline</p> <p><input type="checkbox"/> 5. Other New Construction (Explain)</p> <p><input type="checkbox"/> 6. Other Reconstruction, Maintenance, Repair or Alteration</p> <p><input type="checkbox"/> 7. Demolition</p> <p><input type="checkbox"/> 8. Building Service Contract</p>	<p>8. OCCUPATION FOR PROJECT :</p> <table style="width:100%;"> <tr> <td><input type="checkbox"/> Construction (Building, Heavy Highway/Sewer/Water)</td> <td><input type="checkbox"/> Fuel Delivery</td> </tr> <tr> <td><input type="checkbox"/> Tunnel</td> <td><input type="checkbox"/> Guards, Watchmen</td> </tr> <tr> <td><input type="checkbox"/> Residential</td> <td><input type="checkbox"/> Janitors, Porters, Cleaners, Elevator Operators</td> </tr> <tr> <td><input type="checkbox"/> Landscape Maintenance</td> <td><input type="checkbox"/> Moving furniture and equipment</td> </tr> <tr> <td><input type="checkbox"/> Elevator maintenance</td> <td><input type="checkbox"/> Trash and refuse removal</td> </tr> <tr> <td><input type="checkbox"/> Exterminators, Fumigators</td> <td><input type="checkbox"/> Window cleaners</td> </tr> <tr> <td><input type="checkbox"/> Fire Safety Director, NYC Only</td> <td><input type="checkbox"/> Other (Describe)</td> </tr> </table>	<input type="checkbox"/> Construction (Building, Heavy Highway/Sewer/Water)	<input type="checkbox"/> Fuel Delivery	<input type="checkbox"/> Tunnel	<input type="checkbox"/> Guards, Watchmen	<input type="checkbox"/> Residential	<input type="checkbox"/> Janitors, Porters, Cleaners, Elevator Operators	<input type="checkbox"/> Landscape Maintenance	<input type="checkbox"/> Moving furniture and equipment	<input type="checkbox"/> Elevator maintenance	<input type="checkbox"/> Trash and refuse removal	<input type="checkbox"/> Exterminators, Fumigators	<input type="checkbox"/> Window cleaners	<input type="checkbox"/> Fire Safety Director, NYC Only	<input type="checkbox"/> Other (Describe)
<input type="checkbox"/> Construction (Building, Heavy Highway/Sewer/Water)	<input type="checkbox"/> Fuel Delivery														
<input type="checkbox"/> Tunnel	<input type="checkbox"/> Guards, Watchmen														
<input type="checkbox"/> Residential	<input type="checkbox"/> Janitors, Porters, Cleaners, Elevator Operators														
<input type="checkbox"/> Landscape Maintenance	<input type="checkbox"/> Moving furniture and equipment														
<input type="checkbox"/> Elevator maintenance	<input type="checkbox"/> Trash and refuse removal														
<input type="checkbox"/> Exterminators, Fumigators	<input type="checkbox"/> Window cleaners														
<input type="checkbox"/> Fire Safety Director, NYC Only	<input type="checkbox"/> Other (Describe)														

9. Does this project comply with the Wicks Law involving separate bidding? YES  NO

10. Name and Title of Requester	<b>Signature</b>
---------------------------------	------------------



NEW YORK STATE DEPARTMENT OF LABOR  
Bureau of Public Work - Debarment List

**LIST OF EMPLOYERS INELIGIBLE TO BID ON OR BE  
AWARDED ANY PUBLIC WORK CONTRACT**

Under Article 8 and Article 9 of the NYS Labor Law, a contractor, sub-contractor and/or its successor shall be debarred and ineligible to submit a bid on or be awarded any public work or public building service contract/sub-contract with the state, any municipal corporation or public body for a period of five (5) years from the date of debarment when:

- Two (2) final determinations have been rendered within any consecutive six-year (6) period determining that such contractor, sub-contractor and/or its successor has WILLFULLY failed to pay the prevailing wage and/or supplements;
- One (1) final determination involves falsification of payroll records or the kickback of wages and/or supplements.

The agency issuing the determination and providing the information, is denoted under the heading 'Fiscal Officer'. DOL = New York State Department of Labor; NYC = New York City Comptroller's Office; AG = New York State Attorney General's Office; DA = County District Attorney's Office.

**Debarment Database:** To search for contractors, sub-contractors and/or their successors debarred from bidding or being awarded any public work contract or subcontract under NYS Labor Law Articles 8 and 9, or under NYS Workers' Compensation Law Section 141-b, access the database at this link: <https://apps.labor.ny.gov/EDList/searchPage.do>

**For inquiries please call 518-457-5589.**

**NYSDOL Bureau of Public Work Debarment List 02/18/2025**

**Article 8**

AGENCY	Fiscal Officer	FEIN	EMPLOYER NAME	EMPLOYER DBA NAME	ADDRESS	DEBARMENT START DATE	DEBARMENT END DATE
DOL	DOL	*****5754	0369 CONTRACTORS, LLC		515 WEST AVE UNIT PH 13NORWALK CT 06850	05/12/2021	05/12/2026
DOL	DOL	*****5784	A.J.M. TRUCKING, INC.		PO BOX 2064 MONROE NY 10950	02/12/2024	02/12/2029
DOL	DOL		AKHLAQ OULAKH		4307 28TH AVE ASTORIA NY 11103	10/11/2024	10/11/2029
DOL	NYC		ALL COUNTY SEWER & DRAIN, INC.		7 GREENFIELD DR WARWICK NY 10990	03/25/2022	03/25/2027
DOL	DOL	*****8387	AMERICAN PAVING & MASONRY, CORP.		8 FOREST AVE GLEN COVE NY 11542	05/24/2024	05/24/2029
DOL	DOL	*****8654	AMERICAN PAVING, INC.		8 FORREST AVE. GLEN COVE NY 11542	05/24/2024	05/24/2029
DOL	NYC		AMJED PARVEZ		401 HANOVER AVENUE STATEN ISLAND NY 10304	01/11/2021	01/11/2026
DOL	DOL		ANGELO F COKER		2610 SOUTH SALINA STREET SUITE 14SYRACUSE NY 13205	09/17/2020	09/17/2025
DOL	DOL		ANGELO GARCIA		515 WEST AVE UNIT PH 13NORWALK CT 06850	05/12/2021	05/12/2026
DOL	DOL		ANGELO STANCO		8 FOREST AVE. GLEN COVE NY 11542	05/24/2024	05/24/2029
DOL	DOL		ANGELO TONDO		449 WEST MOMBSHA ROAD MONROE NY 10950	06/06/2022	06/06/2027
DOL	DOL	*****4231	ANKER'S ELECTRIC SERVICE, INC.		10 SOUTH 5TH ST LOCUST VALLEY NY 11560	09/26/2022	09/26/2027
DOL	DOL		ANTHONY MONGELLI		PO BOX 2064 MONROE NY 10950	02/12/2024	02/12/2029
DOL	NYC		ARADCO CONSTRUCTION CORP		115-46 132RD ST SOUTH OZONE PARK NY 11420	09/17/2020	09/17/2025
DOL	NYC		AVM CONSTRUCTION CORP		117-72 123RD ST SOUTH OZONE PARK NY 11420	09/17/2020	09/17/2025
DOL	NYC		AZIDABEGUM		524 MCDONALD AVENUE BROOKLYN NY 11218	09/17/2020	09/17/2025
DOL	DOL	*****8421	B & B DRYWALL, INC		206 WARREN AVE APT 1WHITE PLAINS NY 10603	12/14/2021	12/14/2026
DOL	DOL		B&L RENOVATION CO.		618 OCEAN PARKWAY APT A6BROOKLYN NY 11230	09/17/2020	09/17/2025
DOL	NYC	*****2113	BHW CONTRACTING, INC.		401 HANOVER AVENUE STATEN ISLAND NY 10304	01/11/2021	01/11/2026
DOL	DOL	*****5078	BLACK RIVER TREE REMOVAL, LLC		29807 ANDREWS ROAD BLACK RIVER NY 13032	10/17/2023	10/17/2028
DOL	DOL		BRADLEY J SCHUKA		4 BROTHERS ROAD WAPPINGERS FALLS NY 12590	10/20/2020	10/20/2025
DOL	DOL	*****9383	C.C. PAVING AND EXCAVATING, INC.		2610 SOUTH SALINA ST SUITE 12SYRACUSE NY 13205	09/17/2020	09/17/2025
DOL	DOL	*****4083	C.P.D. ENTERPRISES, INC		P.O BOX 281 WALDEN NY 12586	03/03/2020	03/03/2025
DOL	DOL	*****5161	CALADRI DEVELOPMENT CORP.		1223 PARK ST. PEEKSKILL NY 10566	05/17/2021	05/17/2026
DOL	DOL	*****3391	CALI ENTERPRISES, INC.		1223 PARK STREET PEEKSKILL NY 10566	05/17/2021	05/17/2026
DOL	DOL	*****4155	CASA BUILDERS, INC.	FRIEDLANDER CONSTRUCTI ON	64 N PUTT CONNERS ROAD NEW PALTZ NY 12561	05/10/2023	05/10/2028
DOL	AG	*****7247	CENTURY CONCRETE CORP		2375 RAYNOR ST RONKONKOMA NY 11779	08/04/2021	08/04/2026
DOL	DOL	*****0026	CHANTICLEER CONSTRUCTION LLC		4 BROTHERS ROAD WAPPINGERS FALLS NY 12590	10/20/2020	10/20/2025
DOL	NYC	*****2117	CHARAN ELECTRICAL ENTERPRISES		9-11 40TH AVENUE LONG ISLAND CITY NY 11101	09/26/2023	09/26/2028
DOL	NYC		CHARLES ZAHRADKA		863 WASHINGTON STREET FRANKLIN SQUARE NY 11010	03/10/2020	03/10/2025
DOL	DOL		CHRISTOPHER GRECO		26 NORTH MYRTLE AVENUE SPRING VALLEY NY 10956	02/18/2021	02/18/2026
DOL	DOL	*****2281	CORRAO TRUCKING, INC.		PO BOX 393 NANUET NY 10954	09/17/2024	09/17/2029
DOL	DOL		CRAIG JOHANSEN		10 SOUTH 5TH ST LOCUST VALLEY NY 11560	09/26/2022	09/26/2027
DOL	DOL	*****3228	CROSS-COUNTY LANDSCAPING AND TREE SERVICE, INC.	ROCKLAND TREE SERVICE	26 NORTH MYRTLE AVENUE SPRING VALLEY NY 10956	02/18/2021	02/18/2026

**NYS DOL Bureau of Public Work Debarment List 02/18/2025**

**Article 8**

DOL	DOL	*****7619	DANCO CONSTRUCTION UNLIMITED INC.		485 RAFT AVENUE HOLBROOK NY 11741	10/19/2021	10/19/2026
DOL	DOL		DANIEL ROBERT MCNALLY		7 GREENFIELD DRIVE WARWICK NY 10990	03/25/2022	03/25/2027
DOL	DOL		DARIAN L COKER		2610 SOUTH SALINA ST SUITE 2CSYRACUSE NY 13205	09/17/2020	09/17/2025
DOL	DOL		DARWIN PEGUESE		6400 BALTIMORE NATIONAL SUITE 602CANTONSVILLE NY 21228	10/24/2024	10/24/2029
DOL	DOL		DAVID FRIEDLANDER		64 NORTH PUTT CORNERS RD NEW PALTZ NY 12561	05/10/2023	05/10/2028
DOL	DOL		DINA TAYLOR		64 N PUTT CONNERS RD NEW PALTZ NY 12561	05/10/2023	05/10/2028
DOL	AG		EDWIN HUTZLER		23 NORTH HOWELLS RD BELLPORT NY 11713	08/04/2021	08/04/2026
DOL	DA		EDWIN HUTZLER		2375 RAYNOR STREET RONKONKOMA NY 11779	08/04/2021	08/04/2026
DOL	DOL	*****0780	EMES HEATING & PLUMBING CONTR		5 EMES LANE MONSEY NY 10952	01/20/2002	01/20/3002
DOL	DOL		EMIL KISZKO		84 DIAMOND ST BROOKLYN NY 11222	07/18/2024	07/18/2029
DOL	DOL	*****3298	EMJACK CONSTRUCTION CORP.		84 DIAMOND ST BROOKLYN NY 11222	07/18/2024	07/18/2029
DOL	DOL	*****3298	EMJACK CONSTRUCTION LLC		4192 SIR ANDREW CIRCLE DOYLESTOWN PA 18902	07/18/2024	07/18/2029
DOL	DOL		EUGENIUSZ "GINO" KUCHAR		195 KINGSLAND AVE BROOKLYN NY 11222	12/22/2023	12/22/2028
DOL	DA		FREDERICK HUTZLER		2375 RAYNOR STREET RONKONKOMA NY 11779	08/04/2021	08/04/2026
DOL	DOL	*****2998	G.E.M. AMERICAN CONSTRUCTION CORP.		195 KINGSLAND AVE BROOKLYN NY 11222	12/22/2023	12/22/2028
DOL	NYC		GAYATRI MANGRU		21 DAREWOOD LANE VALLEY STREAM NY 11581	09/17/2020	09/17/2025
DOL	DA		GEORGE LUCEY		150 KINGS STREET BROOKLYN NY 11231	01/19/1998	01/19/2998
DOL	DA		GIOVANNA TRAVALJA		3735 9TH ST LONG ISLAND CITY NY 11101	01/05/2023	01/05/2028
DOL	DA		GIOVANNI NAPOLITANO		2501 BAYVIEW AVENUE WANTAGH NY 11793	02/21/2024	02/21/2029
DOL	DA	*****0213	GORILLA CONTRACTING GROUP, LLC		505 MANHATTAN AVE WEST BABYLON NY 11704	10/05/2023	10/05/2028
DOL	DA	*****4760	GTX CONSTRUCTION ASSOCIATES, CORP		2501 BAYVIEW AVE WANTAGH NY 11793	02/21/2024	02/21/2029
DOL	DOL		HERBERT CLEMEN		42 FOWLER AVENUE CORTLAND MANOR NY 10567	01/24/2023	01/24/2028
DOL	DOL		HERBERT CLEMEN		42 FOWLER AVENUE CORTLAND MANOR NY 10567	10/25/2022	10/25/2027
DOL	DOL	*****2397	ISLAND BREEZE MARINE, INC.		6400 BALTIMORE NATIONAL CANTONSVILLE MD 21228	10/24/2024	10/24/2029
DOL	DOL	*****9211	J. WASE CONSTRUCTION CORP.		8545 RT 9W ATHENS NY 12015	03/09/2021	03/09/2026
DOL	DOL		J.M.J CONSTRUCTION		151 OSTRANDER AVENUE SYRACUSE NY 13205	11/21/2022	11/21/2027
DOL	DOL		J.R. NELSON CONSTRUCTION		531 THIRD STREET ALBANY NY 12206	11/07/2023	11/07/2028
DOL	DOL		J.R. NELSON CONSTRUCTION		531 THIRD STREET ALBANY NY 12206	12/22/2022	12/22/2027
DOL	DOL		J.R. NELSON CONSTRUCTION		531 THIRD STREET ALBANY NY 12206	10/25/2022	10/25/2027
DOL	DOL		J.R. NELSON, LLC		531 THIRD STREET ALBANY NY 12206	12/22/2022	12/22/2027
DOL	DOL		J.R. NELSON, LLC		531 THIRD STREET ALBANY NY 12206	11/07/2023	11/07/2028
DOL	DOL		J.R. NELSON, LLC		531 THIRD STREET ALBANY NY 12206	10/25/2022	10/25/2027
DOL	DOL		J.R.N COMPANIES, LLC		531 THIRD STREET ALBANY NY 12206	12/12/2022	12/12/2027
DOL	DOL		J.R.N COMPANIES, LLC		531 THIRD STREET ALBANY NY 12206	11/07/2023	11/07/2028
DOL	DOL		J.R.N COMPANIES, LLC		531 THIRD STREET ALBANY NY 12206	10/25/2022	10/25/2027
DOL	DOL	*****1147	J.R.N. CONSTRUCTION, LLC		531 THIRD ST ALBANY NY 12206	11/07/2023	11/07/2028
DOL	DOL	*****1147	J.R.N. CONSTRUCTION, LLC		531 THIRD ST ALBANY NY 12206	12/22/2022	12/22/2027

**NYS DOL Bureau of Public Work Debarment List 02/18/2025**

**Article 8**

DOL	DOL	*****1147	J.R.N. CONSTRUCTION, LLC		531 THIRD ST ALBANY NY 12206	10/25/2022	10/25/2027
DOL	DOL		JAMES J. BAKER		7901 GEE ROAD CANASTOTA NY 13032	08/17/2021	08/17/2026
DOL	DOL		JASON P. RACE		3469 STATE RT. 69 PERISH NY 13131	09/29/2021	09/29/2026
DOL	DOL		JASON P. RACE		3469 STATE RT. 69 PERISH NY 13131	02/09/2022	02/09/2027
DOL	DOL		JASON P. RACE		3469 STATE RT. 69 PERISH NY 13131	11/15/2022	11/15/2027
DOL	DOL		JASON P. RACE		3469 STATE RT. 69 PERISH NY 13131	03/01/2022	03/01/2027
DOL	DOL	*****7993	JBS DIRT, INC.		7901 GEE ROAD CANASTOTA NY 13032	08/17/2021	08/17/2026
DOL	DOL	*****2435	JEFFEL D. JOHNSON	JMJ7 AND SON	5553 CAIRNSTRAIL CLAY NY 13041	11/21/2022	11/21/2027
DOL	DOL		JEFFEL JOHNSON ELITE CARPENTER REMODEL AND CONSTRUCTION		C2 EVERGREEN CIRCLE LIVERPOOL NY 13090	11/21/2022	11/21/2027
DOL	DOL	*****2435	JEFFREY M. JOHNSON	JMJ7 AND SON	5553 CAIRNS TRAIL CLAY NY 13041	11/21/2022	11/21/2027
DOL	DOL		JIM PLAUGHER		17613 SANTE FE LINE ROAD WAYNEFIELD OH 45896	07/16/2021	07/16/2026
DOL	DOL		JMJ7 & SON CONSTRUCTION, LLC		5553 CAIRNS TRAIL LIVERPOOL NY 13041	11/21/2022	11/21/2027
DOL	DOL		JMJ7 AND SONS CONTRACTORS		5553 CAIRNS TRAIL CLAY NY 13041	11/21/2022	11/21/2027
DOL	DOL		JMJ7 CONTRACTORS		7014 13TH AVENUE BROOKLYN NY 11228	11/21/2022	11/21/2027
DOL	DOL		JMJ7 CONTRACTORS AND SONS		5553 CAIRNS TRAIL CLAY NY 13041	11/21/2022	11/21/2027
DOL	DOL		JMJ7 CONTRACTORS, LLC		5553 CAIRNS TRAIL CLAY NY 13041	11/21/2022	11/21/2027
DOL	DOL		JOHN MARKOVIC		47 MANDON TERRACE HAWTHORN NJ 07506	03/29/2021	03/29/2026
DOL	DOL		JOHN WASE		8545 RT 9W ATHENS NY 12015	03/09/2021	03/09/2026
DOL	DOL		JORGE RAMOS		8970 MIKE GARCIA DR MANASSAS VA 20109	07/16/2021	07/16/2026
DOL	DOL		JOSEPH K. SALERNO		1010 TILDEN AVE UTICA NY 13501	07/24/2023	07/24/2028
DOL	DOL		JOSEPH K. SALERNO II		1010 TILDEN AVE UTICA NY 13501	07/24/2023	07/24/2028
DOL	DOL	*****5116	JP RACE PAINTING, INC. T/A RACE PAINTING		3469 STATE RT. 69 PERISH NY 13131	02/09/2022	02/09/2027
DOL	DOL	*****5116	JP RACE PAINTING, INC. T/A RACE PAINTING		3469 STATE RT. 69 PERISH NY 13131	11/15/2022	11/15/2027
DOL	DOL	*****5116	JP RACE PAINTING, INC. T/A RACE PAINTING		3469 STATE RT. 69 PERISH NY 13131	09/29/2021	09/29/2026
DOL	DOL	*****5116	JP RACE PAINTING, INC. T/A RACE PAINTING		3469 STATE RT. 69 PERISH NY 13131	03/01/2022	03/01/2027
DOL	DOL	*****5116	JP RACE PAINTING, INC. T/A RACE PAINTING		3469 STATE RT. 69 PERISH NY 13131	03/01/2022	03/01/2027
DOL	DOL		JRN CONSTRUCTION CO, LLC		1024 BROADWAY ALBANY NY 12204	11/07/2023	11/07/2028
DOL	DOL	*****1147	JRN CONSTRUCTION, LLC		531 THIRD STREET ALBANY NY 12206	10/25/2022	10/25/2027
DOL	DOL	*****1147	JRN CONSTRUCTION, LLC		531 THIRD STREET ALBANY NY 12206	12/22/2022	12/22/2027
DOL	DOL	*****1147	JRN CONSTRUCTION, LLC		531 THIRD STREET ALBANY NY 12206	11/07/2023	11/07/2028
DOL	DOL		JRN PAVING, LLC		531 THIRD STREET ALBANY NY 12206	10/25/2022	10/25/2027
DOL	DOL		JRN PAVING, LLC		531 THIRD STREET ALBANY NY 12206	12/22/2022	12/22/2027
DOL	DOL		JRN PAVING, LLC		531 THIRD STREET ALBANY NY 12206	11/07/2023	11/07/2028
DOL	DOL		JULIUS AND GITA BEHREND		5 EMES LANE MONSEY NY 10952	11/20/2002	11/20/3002
DOL	DOL		KARIN MANGIN		796 PHELPS ROAD FRANKLIN LAKES NJ 07417	12/01/2020	12/01/2025
DOL	DOL		KATE E. CONNOR		7088 INTERSTATE ISLAND RD SYRACUSE NY 13209	03/31/2021	03/31/2026

**NYSDOL Bureau of Public Work Debarment List 02/18/2025**

**Article 8**

DOL	DOL		KEAN INDUSTRIES, LLC		2345 RT. 52 SUITE 2NHOPEWELL JUNCTION NY 12533	12/18/2023	12/18/2028
DOL	DOL	*****2959	KELC DEVELOPMENT, INC		7088 INTERSTATE ISLAND RD SYRACUSE NY 13209	03/31/2021	03/31/2026
DOL	DOL		KIMBERLY F. BAKER		7901 GEE ROAD CANASTOTA NY 13032	08/17/2021	08/17/2026
DOL	DOL		KMA GROUP II, INC.		29-10 38TH AVENUE LONG ISLAND CITY NY 11101	10/11/2023	10/11/2028
DOL	DOL	*****1833	KMA GROUP INC.		29-10 38TH AVENUE LONG ISLAND CITY NY 11101	10/11/2023	10/11/2028
DOL	DOL		KMA INSULATION, INC.		29-10 38TH AVENUE LONG ISLAND CITY NY 11101	10/11/2023	10/11/2028
DOL	DOL		KRIN HEINEMANN		2345 ROUTE 52, SUITE 2N HOPEWELL JUNCTION NY 12533	12/18/2023	12/18/2028
DOL	NYC		KULWANT S. DEOL		9-11 40TH AVENUE LONG ISLAND CITY NY 11101	09/26/2023	09/26/2028
DOL	DA	*****8816	LAKE CONSTRUCTION AND DEVELOPMENT CORPORATION		150 KINGS STREET BROOKLYN NY 11231	08/19/1998	08/19/2998
DOL	DOL		LEROY E. NELSON JR		531 THIRD ST ALBANY NY 12206	10/25/2022	10/25/2027
DOL	DOL		LEROY E. NELSON JR		531 THIRD ST ALBANY NY 12206	12/22/2022	12/22/2027
DOL	DOL		LEROY E. NELSON JR		531 THIRD ST ALBANY NY 12206	11/07/2023	11/07/2028
DOL	AG	*****3291	LINTECH ELECTRIC, INC.		3006 TILDEN AVE BROOKLYN NY 11226	02/16/2022	02/16/2027
DOL	DOL		LOUIS A. CALICCHIA		1223 PARK ST. PEEKSKILL NY 10566	05/17/2021	05/17/2026
DOL	DOL	*****2196	MAINSTREAM SPECIALTIES, INC.		11 OLD TOWN RD SELKIRK NY 12158	02/02/2021	02/02/2026
DOL	DA		MANUEL P TOBIO		150 KINGS STREET BROOKLYN NY 14444	08/19/1998	08/19/2998
DOL	DA		MANUEL TOBIO		150 KINGS STREET BROOKLYN NY 11231	08/19/1998	08/19/2998
DOL	DOL		MAQSOOD AHMAD		618 OCEAN PKWY BROOKLYN NY 11230	09/17/2020	09/17/2025
DOL	NYC		MARIA NUBILE		84-22 GRAND AVENUE ELMHURST NY 11373	03/10/2020	03/10/2025
DOL	DOL	*****1320	MJC MASON CONTRACTING, INC.		42 FOWLER AVENUE CORTLAND MANOR NY 10567	10/25/2022	10/25/2027
DOL	DOL	*****1320	MJC MASON CONTRACTING, INC.		42 FOWLER AVENUE CORTLAND MANOR NY 10567	01/24/2023	01/24/2028
DOL	NYC		MUHAMMED A. HASHEM		524 MCDONALD AVENUE BROOKLYN NY 11218	09/17/2020	09/17/2025
DOL	NYC		NAMOW, INC.		84-22 GRAND AVENUE ELMHURST NY 11373	03/10/2020	03/10/2025
DOL	DOL	*****7790	NATIONAL BUILDING & RESTORATION CORP		1010 TILDEN AVE UTICA NY 13501	07/24/2023	07/24/2028
DOL	DOL	*****1797	NATIONAL CONSTRUCTION SERVICES, INC		1010 TILDEN AVE UTICA NY 13501	07/24/2023	07/24/2028
DOL	NYC		NAVIT SINGH		402 JERICHO TURNPIKE NEW HYDE PARK NY 11040	08/10/2022	08/10/2027
DOL	DOL		NELCO CONTRACTING, LLC		1024 BROADWAY ALBANY NY 12204	11/07/2023	11/07/2028
DOL	DA		NICHOLAS T. ANALITIS		505 MANHATTAN AVE WEST BABYLON NY 11704	10/05/2023	10/05/2028
DOL	DOL		NICHOLE E. FRASER A/K/A NICHOLE RACE		3469 STATE RT. 69 PERISH NY 13131	03/01/2022	03/01/2027
DOL	DOL		NICHOLE E. FRASER A/K/A NICHOLE RACE		3469 STATE RT. 69 PERISH NY 13131	11/15/2022	11/15/2027
DOL	DOL		NICHOLE E. FRASER A/K/A NICHOLE RACE		3469 STATE RT. 69 PERISH NY 13131	09/29/2021	09/29/2026
DOL	DOL		NICHOLE E. FRASER A/K/A NICHOLE RACE		3469 STATE RT. 69 PERISH NY 13131	02/09/2022	02/09/2027
DOL	DOL	*****7429	NICOLAE I. BARBIR	BESTUCCO CONSTRUCTI ON, INC.	444 SCHANTZ ROAD ALLEN TOWN PA 18104	09/17/2020	09/17/2025
DOL	NYC	*****5643	NYC LINE CONTRACTORS, INC.		402 JERICHO TURNPIKE NEW HYDE PARK NY 11040	08/10/2022	08/10/2027
DOL	DOL		PATRICK PENNACCHIO		2345 RT. 52 SUITE 2NHOPEWELL JUNCTION NY 12533	12/18/2023	12/18/2028



**NYSDOL Bureau of Public Work Debarment List 02/18/2025**

**Article 8**

DOL	DOL		PATRICK PENNACCHIO		2345 RT. 52 SUITE 2NHOPEWELL JUNCTION NY 12533	12/18/2023	12/18/2028
DOL	DOL		PAULINE CHAHALES		935 S LAKE BLVD MAHOPAC NY 10541	03/02/2021	03/02/2026
DOL	DOL		PETER STEVENS		11 OLD TOWN ROAD SELKIRK NY 12158	02/02/2021	02/02/2026
DOL	DOL		PETER STEVENS		8269 21ST ST BELLEROSE NY 11426	12/22/2022	12/22/2027
DOL	DOL	****4168	PHANTOM CONSTRUCTION CORP.		95-27 116TH STREET QUEENS NY 11419	07/12/2024	07/12/2029
DOL	DOL	****4168	PHANTOM CONSTRUCTION CORP.		95-27 116TH STREET QUEENS NY 11419	05/28/2024	05/28/2029
DOL	DOL	****0466	PRECISION BUILT FENCES, INC.		1617 MAIN ST PEEKSKILL NY 10566	03/03/2020	03/03/2025
DOL	NYC		RASHEL CONSTRUCTION CORP		524 MCDONALD AVENUE BROOKLYN NY 11218	09/17/2020	09/17/2025
DOL	DOL	****2633	RAW POWER ELECTRIC CORP.		3 PARK CIRCLE MIDDLETOWN NY 10940	07/11/2022	07/11/2027
DOL	DA	****7559	REGAL CONTRACTING INC.		24 WOODBINE AVE NORTHPORT NY 11768	10/01/2020	10/01/2025
DOL	DOL		RICHARD REGGIO		1617 MAIN ST PEEKSKILL NY 10566	03/03/2020	03/03/2025
DOL	DOL		ROBBYE BISSEAR		89-51 SPRINGFIELD BLVD QUEENS VILLAGE NY 11427	01/11/2003	01/11/3003
DOL	DOL		ROMEO WARREN		161 ROBYN RD MONROE NY 10950	07/11/2022	07/11/2027
DOL	DOL	****7172	RZ & AL INC.		198 RIDGE AVENUE VALLEY STREAM NY 11581	06/06/2022	06/06/2027
DOL	DOL		SAL FRESINA MASONRY CONTRACTORS, INC.		1935 TEALL AVENUE SYRACUSE NY 13206	07/16/2021	07/16/2026
DOL	DOL		SAL MASONRY CONTRACTORS, INC.		(SEE COMMENTS) SYRACUSE NY 13202	07/16/2021	07/16/2026
DOL	DOL	****9874	SALFREE ENTERPRISES INC		P.O BOX 14 2821 GARDNER RDPOMPEI NY 13138	07/16/2021	07/16/2026
DOL	DOL		SALVATORE A FRESINA A/K/A SAM FRESINA		107 FACTORY AVE P.O BOX 11070SYRACUSE NY 13218	07/16/2021	07/16/2026
DOL	DOL		SAM FRESINA		107 FACTORY AVE P.O BOX 11070SYRACUSE NY 13218	07/16/2021	07/16/2026
DOL	DA	****0476	SAMCO ELECTRIC CORP.		3735 9TH ST LONG ISLAND CITY NY 11101	01/05/2023	01/05/2028
DOL	NYC	****1130	SCANA CONSTRUCTION CORP.		863 WASHINGTON STREET FRANKLIN SQUARE NY 11010	03/10/2020	03/10/2025
DOL	DOL	****2045	SCOTT DUFFIE	DUFFIE'S ELECTRIC, INC.	P.O BOX 111 CORNWALL NY 12518	03/03/2020	03/03/2025
DOL	DOL		SCOTT DUFFIE		P.O BOX 111 CORNWALL NY 12518	03/03/2020	03/03/2025
DOL	DA		SILVANO TRAVALJA		3735 9TH ST LONG ISLAND CITY NY 11101	01/05/2023	01/05/2028
DOL	DOL	****0440	SOLAR GUYS INC.		8970 MIKE GARCIA DR MANASSAS VA 20109	07/16/2021	07/16/2026
DOL	NYC		SOMATIE RAMSUNAHAI		115-46 132ND ST SOUTH OZONE PARK NY 11420	09/17/2020	09/17/2025
DOL	NYC	****3661	SPANIER BUILDING MAINTENANCE CORP		200 OAK DRIVE SYOSSET NY 11791	03/14/2022	03/14/2027
DOL	DOL		STANADOS KALOGELAS		485 RAFT AVENUE HOLBROOK NY 11741	10/19/2021	10/19/2026
DOL	DOL	****3496	STAR INTERNATIONAL INC		89-51 SPRINGFIELD BLVD QUEENS VILLAGE NY 11427	08/11/2003	08/11/3003
DOL	DOL	****9528	STEEL-IT, LLC.		17613 SANTE FE LINE ROAD WAYNESFIELD OH 45896	07/16/2021	07/16/2026
DOL	DOL	****3800	SUBURBAN RESTORATION CO. INC.		5-10 BANTA PLACE FAIR LAWN PLACE NJ 07410	03/29/2021	03/29/2026
DOL	DOL	****9150	SURGE INC.		8269 21ST STREET BELLEROSE NY 11426	12/22/2022	12/22/2027
DOL	DOL		SYED MUHAMMAD S. JAFRI A/K/A SHARRUKH JAFRI		4307 28TH AVE ASTORIA NY 11103	10/11/2024	10/11/2029
DOL	DOL		SYED RAZA		198 RIDGE AVENUE NY 11581	06/06/2022	06/06/2027
DOL	DOL		TARLOK SINGH		95-27 116TH STREET QUEENS NY 11419	05/28/2024	05/28/2029

**NYS DOL Bureau of Public Work Debarment List 02/18/2025**

**Article 8**

DOL	DOL		TARLOK SINGH		95-27 116TH STREET QUEENS NY 11419	07/12/2024	07/12/2029
DOL	DOL	*****9733	TERSAL CONSTRUCTION SERVICES INC		107 FACTORY AVE P.O BOX 11070SYRACUSE NY 13208	07/16/2021	07/16/2026
DOL	DOL		TERSAL CONTRACTORS, INC.		221 GARDNER RD P.O BOX 14POMPEI NY 13138	07/16/2021	07/16/2026
DOL	DOL		TERSAL DEVELOPMENT CORP.		1935 TEALL AVENUE SYRACUSE NY 13206	07/16/2021	07/16/2026
DOL	DOL	*****5766	THE COKER CORPORATION	COKER CORPORATIO N	2610 SOUTH SALINA ST SUITE 14SYRACUSE NY 13205	09/17/2020	09/17/2025
DOL	DOL	*****2426	THE MATRUKH GROUP, INC.		4307 28TH AVE PO BOX 9082ASTORIA NY 11103	10/11/2024	10/11/2029
DOL	DOL		TIMOTHY PERCY		29807 ANDREWS ROAD BLACK RIVER NY 13612	10/17/2023	10/17/2028
DOL	DA	*****1050	TRI STATE CONSTRUCTION OF NY CORP.		50-39 175TH PLACE FRESH MEADOWS NY 11365	03/28/2022	03/28/2027
DOL	DA	*****4106	TRIPLE H CONCRETE CORP		2375 RAYNOR STREET RONKONKOMA NY 11779	08/04/2021	08/04/2026
DOL	DOL	*****8210	UPSTATE CONCRETE & MASONRY CONTRACTING CO INC		449 WEST MOMBSHA ROAD MONROE NY 10950	06/06/2022	06/06/2027
DOL	DOL	*****6418	VALHALLA CONSTRUCTION, LLC.		796 PHELEPS ROAD FRANKLIN LAKES NJ 07417	12/01/2020	12/01/2025
DOL	NYC	*****2426	VICKRAM MANGRU	VICK CONSTRUCTI ON	21 DAREWOOD LANE VALLEY STREAM NY 11581	09/17/2020	09/17/2025
DOL	NYC		VICKRAM MANGRU		21 DAREWOOD LANE VALLEY STREAM NY 11581	09/17/2020	09/17/2025
DOL	DOL		VINCENT CORRAO		PO BOX 393 NANUET NY 10954	09/17/2024	09/17/2029
DOL	DOL	*****8266	WILLIAM CHRIS MCCLENDON	MCCLENDON ASPHALT PAVING	1646 FALLS STREET NIAGARA FALLS NY 14303	05/01/2023	05/01/2028
DOL	DOL		WILLIAM CHRIS MCCLENDON		1646 FALLS STREET NIAGARA FALLS NY 14303	05/01/2023	05/01/2028
DOL	DOL		WILLIAM G. PROERFRIEDT		85 SPRUCEWOOD ROAD WEST BABYLON NY 11704	01/19/2021	01/19/2026
DOL	DOL	*****5924	WILLIAM G. PROPHY, LLC	WGP CONTRACTIN G, INC.	54 PENTAQUIT AVE BAYSHORE NY 11706	01/19/2021	01/19/2026
DOL	DOL		WILLIAM SCRIVENS		4192 SIR ANDREW CIRCLE DOYELSTOWN PA 18902	07/18/2024	07/18/2029
DOL	DOL		XENOFON EFTHIMIADIS		29-10 38TH AVENUE LONG ISLAND CITY NY 11101	10/11/2023	10/11/2028

## **APPENDIX C**

### **INSURANCE REQUIREMENTS**

I. The Contractor and each of its subcontractors shall procure and maintain during the entire term of the contract the following required insurance:

→ **Contractor's Liability Insurance**

\$1,000,000 per occurrence/ \$2,000,000 aggregate, including coverage for liability assumed by contract, completed operations, explosion, collapse, underground hazard and products liability.

→ **Workers' Compensation**

Statutory Workers' Compensation and Employers' Liability Insurance for all employees.

→ **Excess/Umbrella Liability Insurance**

\$1,000,000 per occurrence / \$2,000,000 aggregate.

II. Notwithstanding any terms, conditions or provisions, in any other writing between the parties, the Contractor hereby agrees to name the County as:

→ an additional insured on the Contractor's Liability, and Excess/Umbrella Liability insurance policies.

III. The policy/policies of insurance furnished by the Contractor shall:

→ be from an A.M. Best rated "A" New York State licensed insurer; and

→ contain a 30-day notice of cancellation

IV. The Contractor agrees to indemnify the County for any applicable deductibles.

V. Contractor acknowledges that failure to obtain such insurance on behalf of the County constitutes a material breach of contract and subjects it to liability for damages, indemnification and all other legal remedies available to the County. Prior to commencement of work or use of facilities, the Contractor shall provide to the County proof that such requirements have been met by furnishing certificate(s) of such insurance, and the declarations pages from the policies of such insurance. The failure of the County to object to the contents of the certificate(s) and/or declarations pages, or the absence of same, shall not be deemed a waiver of any and all rights held by the County.

VI. All certificates of insurance will provide 30 days notice to the county of cancellation or non-renewal.

VII. Contractor and subcontractor waives all rights of subrogation against the owner and will have the General Liability, Umbrella Liability Workers' Compensation policies endorsed setting forth this Waiver of Subrogation.

## **APPENDIX D - STANDARD CLAUSES FOR TOWN OF SCHROON CONTRACTS**

### **1. Independent Contractor Status**

The parties each acknowledge, covenant and agree that the relationship of the Contractor to the Town shall be that of an independent contractor. The Contractor, in accordance with its status as an independent contractor, further covenants and agrees that it:

- (a) will conduct itself in accordance with its status as an independent contractor;
- (b) will neither hold itself out as nor claim to be an officer or employee of the Town; and
- (c) will not make any claim, demand or application for any right or privilege applicable to an officer or employee of the Town, including but not limited to workers' compensation benefits, unemployment insurance benefits, social security coverage or retirement membership or credits.

### **2. Contractor To Comply With Laws/Regulations**

The Contractor shall at all times comply with all applicable state and federal laws, rules and regulations governing the performance and rendition of the services to be furnished under this agreement.

### **3. Licenses, Permits, Etc.**

The Contractor shall, during the term of this agreement, obtain and keep in full force and effect any and all licenses, permits and certificates required by any governmental authority having jurisdiction over the rendition and performance of the services to be furnished by the Contractor under this agreement.

### **4. Termination**

This agreement may be terminated without cause by either party upon 30 days prior written notice, and upon such termination neither party shall have any claim or cause of action against the other except for services actually performed and mileage expenses actually incurred prior to such termination. Notwithstanding the foregoing, this agreement may be immediately terminated by the Town:

- (a) for the Contractor's breach of this agreement, by serving written notice of such termination stating the nature of the breach upon the Contractor by personal delivery or by certified mail, return receipt requested, and upon such termination either party shall have such rights and remedies against the other as provided by law; or
- (b) upon the reduction or discontinuance of funding by the State or Federal governments to be used in furnishing some or all of the work, labor and/or services provided for under this agreement, and upon such termination neither party shall have any claim or cause of action against the other except for services actually performed and expenses (if the same are to be paid under this agreement) actually incurred prior to such termination.

### **5. Defense & Indemnification**

The Contractor shall defend, indemnify and hold harmless the Town to the fullest extent allowed by law from and against any and all liability, suits, judgments, orders, causes of action, and claims, including but not limited to those for bodily injury, property damage, death, and reasonable attorney's fees, arising out of or in connection with the Contractor's negligence and/or its performance or failure to perform this agreement

6. **Discrimination Prohibited**

The services to be furnished and rendered under this agreement by the Contractor shall be available to any and all residents of Essex Town without regard to race, color, creed, sex, religion, national or ethnic origin, handicap, or source of payment; and under no circumstances shall a resident's financial ability to pay for the services provided be considered unless such consideration is allowed by State and/or Federal law, rule or regulation.

7. **Non-Discrimination In Employment**

The Contractor will not discriminate against any employee or applicant for employment because of race, creed, color, sex, national origin, age, disability or marital status. In the event that this is a contract to be performed in whole or in part within the State of New York for (a) the construction, alteration or repair of any public building or public work, (b) for the manufacture, sale or distribution of materials, equipment or supplies, (c) for building service, the Contractor agrees that neither it nor its subcontractors shall, by reason of race, creed, color, disability, sex or national origin:

- (1) discriminate in hiring against any citizen who is qualified and available to perform the work; or
- (2) discriminate against or intimidate any employee hired for the performance of work under this contract.

The Contractor agrees to be subject to fines of \$50.00 per person per day for any violation of this paragraph, as well as to possible termination of this contract or forfeiture of all moneys due hereunder for a second or subsequent violation.

8. **Damage/Injury To Persons & Property**

The Contractor shall promptly advise the Town of all damages to property of the Town or of others, or of injuries incurred by persons other than employees of the Contractor, in any manner relating, either directly or indirectly, to the performance of this agreement.

9. **Records**

The Contractor shall establish and maintain complete and accurate books, records, documents, accounts and other evidence directly pertinent to performance under this contract (hereinafter collectively "the Records") in accordance with the following requirements:

- (a) the Records must be kept for the balance of the calendar year in which they were made and for six (6) additional years thereafter;
- (b) the Town Auditor, State Comptroller, the Attorney General or any other person or entity authorized to conduct an examination, as well as the agency or agencies involved in this contract, shall have access to the Records during normal business hours at an office of the Contractor within the State of New York, or, if no such office is available, at a mutually agreeable and reasonable venue within the State, for the term specified above for the purposes of inspection, auditing and copying.

The Town shall take reasonable steps to protect from public disclosure any of the records which are exempt from disclosure under Section 87 of the Public Officers Law (the "Statute") provided that: (i) the Contractor shall timely inform an appropriate Town official, in writing, that said records should not be disclosed; and (ii) said records shall be sufficiently identified and designation of said records as exempt under the statute is reasonable. Nothing contained herein shall diminish, or in any way adversely affect, the Town's right to discovery in any pending or future litigation.

10. **Claims For Payment**

All invoices or claims for which payment is sought from the Town must be submitted in accordance with the following:

- (a) each claim for payment must include
  - (1) an invoice detailing the claim,
  - (2) copies of all documentation supporting the claim,
  - (3) a properly completed Town standard voucher, which includes
    - (i) the Town contract number under which payment is being claimed, **AND**
    - (ii) the payee's Federal employer identification number or Federal social security number, or both such numbers when the payee has both such numbers. *[Failure to include this number or numbers will prevent and preclude payment by the Town; except that where the payee does not have such number or numbers, the payee, on the invoice or Town voucher, must give the reason or reasons why the payee does not have such number or numbers and such reasons constitute a valid excuse under law.]*
- (b) Unless otherwise provided in this agreement, each claim for payment must be submitted to the Town no later than 30 days after the work, labor, materials, and/or services for which payment is claimed were rendered or furnished.
- (c) Notwithstanding any other provision of this agreement, no claim for payment shall be valid, and the Town shall not be liable for payment thereof, unless it is submitted to the Town within 30 days of the close of the calendar year in which the work, labor, materials, and/or services for which payment is claimed were rendered or furnished.

- (d) Unless otherwise provided in this agreement, the requirements of this paragraph 10, and/or of any other provisions of this agreement which supersede the same, shall constitute conditions precedent to the Town's payment obligation, and failure to comply with any or all of said requirements shall entitle the Town to deny payment.

11. **Consent**

In the event that State or Federal law requires the recipient of services to be furnished and rendered under this agreement to give his/her prior consent thereto, the contractor shall obtain such person's consent and furnish proof thereof to the Town.

12. **Executory Clause**

The Town shall have no liability under this contract to the Contractor or to anyone else beyond the funds appropriated and available for this contract.

13. **Public Work & Building Service Contract Requirements**

If this is a public work contract covered by Article 8 of the Labor Law or a building service contract covered by Article 9 thereof:

- (a) neither the Contractor's employees nor the employees of its subcontractors may be required or permitted to work more than the number of hours or days stated in said statutes, except as otherwise provided in the Labor Law and as set forth in prevailing wage and supplement schedules issued by the State Labor Department; and
- (b) the Contractor and its subcontractors must pay at least the prevailing wage rate and pay or provide the prevailing supplements, including the premium rates for overtime pay, as determined by the State Labor Department in accordance with the Labor Law.

14. **Public Work Contracts – Hazardous Substances**

If this is a contract for public work, the Contractor agrees as follows:

- (a) the Contractor acknowledges that the Town uses and/or produces various substances which may be classified as hazardous under OSHA's Hazard Communication Standard;
- (b) the Contractor recognizes the use of said substances by the Town and acknowledges that the Town has provided, or upon request will provide, the Contractor with a description of such substances which may be present in the area of the Town's facility/facilities to which the Contractor may have accessed during the performance of this contract;
- (c) the Contractor acknowledges that the Town has provided, or upon request will provide, suggestions for appropriate protective measures which should be observed when the Contractor is in the area of any such hazardous substances;
- (d) the Contractor agrees to be solely responsible for providing training and information to its employees regarding any such hazardous substances, as well as of any protective measures suggested by the Town;

- (e) the Contractor agrees to be solely responsible to ensure that the Contractor's employees observe protective measures during the performance of their duties in the performance of the contract, and that all such protective measures will be at least as stringent as those suggested or which would have been suggested by the Town;
- (f) in the event that the Contractor's performance of the work under this contract requires the use of any hazardous substances, the Contractor shall notify the Town in advance of bringing in and/or using such substances in or upon Town property and suggest to the Town appropriate measures to be observed by the Town, its officers and employees, and/or the public; and
- (g) in the event the Contractor fails in whole or in part to comply with the terms of this paragraph, the Town shall have the right to interrupt the Contractor's work and/or terminate this contract, and the Contractor shall be prohibited from renewing such work until all applicable safety and health procedures and practices are implemented by the Contractor.

15. **Disputes**

Disputes involving this contract, including the breach or alleged breach thereof, may not be submitted to binding arbitration, but must, instead, be heard in a court of competent jurisdiction within the State of New York.

16. **Non-Assignment**

This agreement may not be assigned, subcontracted, transferred, conveyed, sublet or otherwise disposed of in whole or in part, by the Contractor, without the prior written consent of the Town, and any attempts to assign the contract without the Town's written consent are null and void.

17. **No Collusion**

If this contract was awarded based upon the submission of bids, the Contractor warrants, under penalty of perjury, that:

- (a) its bid was arrived at independently and without collusion aimed at restricting competition; and
- (b) at the time Contractor submitted its bid, an authorized and responsible person executed and delivered to the Town a non-collusive bidding certification on Contractor's behalf.

18. **International Boycott**

In accordance with Section 220-f of the Labor Law, if this contract exceeds \$5,000.00, the Contractor agrees, as a material condition of the contract, that neither the Contractor nor any substantially owned or affiliated person, firm, partnership or corporation, has participated, is participating, or shall participate in an International boycott in violation of the federal Export Administration Act of 1979, or regulations thereunder. If such contractor, or any of the aforesaid affiliates of Contractor, is convicted, or is otherwise found to have violated said laws or regulations upon the final determination of the United States Commerce



Department or any other appropriate agency of the United States subsequent to the contract's execution, such contract, amendment or modification thereto shall be rendered forfeit and void. The Contractor shall so notify the Town Manager within five (5) business days of such conviction, determination or disposition of appeal.

19. **Town's Rights of Set-Off**

The Town shall have all of its common law, equitable and statutory rights of set-off. These rights shall include, but not be limited to, the Town's option to withhold for the purposes of set-off any moneys due to the Contractor under this agreement up to any amounts due and owing to the Town with regard to this contract, any other contract with any Town department or agency, including any contract for a term commencing prior to the term of this contract, plus any amounts due and owing to the Town for any other reason, including, without limitation, tax delinquencies, fee delinquencies or monetary penalties relative thereto. The Town shall exercise its set-off rights in accordance with normal Town practices, including, in cases of set-off pursuant to an audit, the acceptance of such audit by the Town Board of Supervisors or its designated representative.

20. **Contractor Defined**

Whenever the term "Contractor" is used in this agreement, such term shall include and apply to all employees, all officers, directors and agents, if any, of the Contractor.

21. **Amendment**

This agreement may not be amended, modified or renewed except by written agreement signed by the Contractor and the Town.

22. **Ownership Of Work Products**

All final and written or tangible work products completed by the Contractor shall belong to the Town. In the event of premature discontinuance of performance, the Contractor agrees to deliver all existing products and data files to the Town.

23. **Executive Order Debarment/Suspension**

In the event that this contract involves the Contractor furnishing goods and services in excess of \$100,000.00, or constitutes a subaward to subrecipients, under any Federal program, grant or other funding source, then by executing this agreement the Contractor certifies that neither it nor any of its principals are suspended or debarred within the scope or meaning of Executive Orders 12549 and 12689, any Federal or State regulation implementing or codifying the same, or any other Federal or State law, rule or regulation.

24. **Health Insurance Portability and Accountability Act of 1996 (HIPAA)**

In the event that this contract involves the use or disclosure of protected health information within the meaning or application of the Health Insurance

Portability and Accountability Act of 1996 (HIPAA), and the regulations thereunder, the following provisions of this paragraph shall apply.

- (a) Definitions. The terms used, but not otherwise defined, in this Agreement shall have the same meaning as given such terms in 45 CFR §160.103 and §164.501, as the same may be amended from time to time, including but not limited to the following.
- (1) "Business Associate" shall mean the Contractor, its officers, employees, agents and subcontractors.
  - (2) "Covered Entity" shall mean Essex Town (the "Town"), its departments, agencies, officers and employees.
  - (3) "Individual" shall have the same meaning as given such term in 45 CFR §164.501 and shall also include a person who qualifies as a personal representative in accordance with 45 CFR §164.502(g).
  - (4) "Privacy Rule" shall mean the Standards for Privacy of Individually Identifiable Health Information at 45 CFR Part 160 and Part 164, subparts A and E.
  - (5) "Protected Health Information" shall have the same meaning as given such term in 45 CFR §164.501, limited to the information created or received by Contractor from or on behalf of the Town.
  - (6) "Required by law" shall have the same meaning as given such term in 45 CFR §164.501.
  - (7) "Secretary" shall mean the Secretary of the Department of Health and Human Services or his/her designee.
- (b) Obligations and Activities of Contractor.  
Contractor agrees to:
- (1) not use or disclose Protected Health Information other than as permitted or required by this Agreement or as required by law;
  - (2) use appropriate safeguards to prevent use or disclosure of the Protected Health Information other than as provided for by this Agreement;
  - (3) mitigate, to the extent practicable, any harmful effect that is known, should have been known, and/or discovered to/by Contractor of a use or disclosure of Protected Health Information by Contractor in violation of the requirements of this Agreement;
  - (4) report to the Town any use or disclosure of the Protected Health Information not provided for by this Agreement of which it becomes aware;
  - (5) ensure that any agent, including a subcontractor, to whom it provides Protected Health Information received from, or created or received by Contractor on behalf of the Town agrees to the same restrictions and conditions that apply through this Agreement to Contractor with respect to such information;
  - (6) provide access, at the request of the Town, and in the time and manner designated by the Town or the Secretary, to Protected Health Information in a Designated Record Set, to the Town or, as directed by the

Town, to an Individual in order to meet the requirements under 45 CFR §164.524;

(7) make any amendment(s) to Protected Health Information in a Designated Record Set that the Town directs or agrees to pursuant to 45 CFR §164.526 at the request of the Town or an Individual, and in the time and manner designated by the Town or the Secretary;

(8) make internal practices, books, and records, including policies and procedures and Protected Health Information, relating to the use and disclosure of Protected Health Information received from, or created or received by Contractor on behalf of, the Town available to the Town, and/or to the Secretary, in a time and manner designated by the Town or by the Secretary, for purposes of the Secretary determining the Town's compliance with the Privacy Rule;

(9) document such disclosures of Protected Health Information and information related to such disclosures as would be required for the Town to respond to a request by an Individual for an accounting of disclosures of Protected Health Information in accordance with 45 CFR §164.528;

(10) provide to the Town or an Individual, in time and manner designated by the Town or the Secretary, information collected in accordance with the above subparagraph (b)(9) of this Agreement, to permit the Town to respond to a request by an Individual for an accounting of disclosures of Protected Health Information in accordance with 45 CFR §164.528.

(c) Permitted Uses and Disclosures by Contractor.

Except as otherwise limited in this Agreement, Contractor may use or disclose Protected Health Information on behalf of, or to provide services to, the persons entitled to services under this Agreement:

(1) solely for the purposes of performing Contractor's obligations under this Agreement, if such use or disclosure of Protected Health Information would not violate the Privacy Rule if done by the Town or the minimum necessary policies and procedures of the Town; or

(2) provided that such use or disclosures are required by law; or

(3) Contractor

(A) obtains written authorization(s) from the individual to which the information pertains permitting the specific uses or disclosures of such information to third persons,

(B) represents and agrees in writing with such individual that the information to be used and/or disclosed will remain confidential and used or further disclosed only as required by law or for the purposes specified in the written authorization(s), and

(C) such third persons agree in writing to notify the Town as soon as practicable and in writing of any instances of which such third person(s) is/are aware in which the confidentiality of the information has been breached; or

- (4) provide Data Aggregation services to the Town as permitted by 42 CFR §164.504(e)(2)(i)(B); or
- (5) report violations of law to appropriate Federal and State authorities, consistent with §164.502(j)(1).

(d) Town To Inform Contractor of Privacy Practices and Restrictions.

The Town agrees to notify the Contractor of any

- (1) limitation(s) in its notice of privacy practices of the Town in accordance with 45 CFR §164.520, to the extent that such limitation may affect the Contractor's use or disclosure of Protected Health Information;
- (2) changes in, or revocation of, permission by Individual to use or disclose Protected Health Information, to the extent that such changes may affect the Contractor's use or disclosure of Protected Health Information; and/or
- (3) restriction to the use or disclosure of Protected Health Information that the Town has agreed to in accordance with 45 CFR §164.522, to the extent that such restriction may affect Contractor's use or disclosure of Protected Health Information.

(e) Permissible Requests by Town.

The Town shall not request Contractor to use or disclose Protected Health Information in any manner that would not be permissible under the Privacy Rule if done by the Town; except that in the event that the services to be furnished by the Contractor under this Agreement requires data aggregation by the Contractor, the Contractor may use or disclose protected health information for such data aggregation or management and administrative activities of Contractor.

(f) Survival of Provisions.

The obligations of the Contractor under this paragraph 24 shall survive the expiration of the term of this Agreement and/or the termination of this Agreement, and said obligations shall remain effective and shall not terminate until all of the Protected Health Information provided by the Town to Contractor, or created or received by Contractor on behalf of the Town, is destroyed or returned to the Town, or, if it is infeasible to return or destroy Protected Health Information, protections are extended to such information, in accordance with the termination provisions in subparagraph (g) below.

(g) Return or Destruction of Protected Health Information.

Except as otherwise provided below, upon termination of this Agreement for any reason, Contractor shall return or destroy all Protected Health Information received from the Town, or created or received by Contractor on behalf of the Town. This provision shall apply to Protected Health Information that is in the possession of subcontractors or agents of Contractor. Contractor shall retain no copies of the Protected Health Information.

In the event that Contractor determines that returning or destroying the Protected Health Information is infeasible, Contractor shall provide to the Town notification of the conditions that make return or destruction infeasible. Upon determination by the Town that return or destruction of Protected Health

Information is infeasible, Contractor shall extend the protections of this Agreement to such Protected Health Information and limit further uses and disclosures of such Protected Health Information to those purposes that make the return or destruction infeasible, for so long as Contractor maintains such Protected Health Information.

(h) Termination for Cause.

Upon the Town's knowledge of a material breach of this paragraph by Contractor, the Town shall:

- (1) either:
  - (A) provide an opportunity for Contractor to cure the breach or end the violation and terminate this Agreement within the time specified by the Town, or
  - (B) immediately terminate this Agreement if cure is not possible;
- (2) report the violation to the Secretary.

(i) Miscellaneous.

- (1) **Regulatory References.** A reference in this Agreement to a section in the Privacy Rule means the section as in effect or as amended.
- (2) **Amendment.** The Parties agree to take such action as is necessary to amend this Agreement from time to time as is necessary for the Town to comply with the requirements of the Privacy Rule and the Health Insurance Portability and Accountability Act of 1996, Pub. L. No. 104-191.
- (3) **Survival.** The respective rights and obligations of Contractor under this paragraph 24 of this Agreement shall survive the termination of this Agreement.
- (4) **Interpretation.** Any ambiguity in this Agreement shall be resolved to permit the Town to comply with the Privacy Rule.

25. Severability

If any term or provision of this agreement or the application thereof to any person or circumstance shall to any extent be held invalid or unenforceable, the remainder of this agreement or the application of such term or provision to persons or circumstances other than those as to which it is held invalid or unenforceable, shall not be affected thereby and every other term and provision of this agreement shall be valid and be enforced to the fullest extent permitted by law.

26. Entire Agreement

This agreement is the entire agreement between the parties, and the same shall be construed in accordance with the laws of the State of New York.

27. In addition to those items required at Paragraph 10 of this Appendix, as conditions for payment, each claim of payment shall be accompanied by a Contractor and Sub-Contractor Progress Payment Waiver, Release and

Discharge form in the form attached hereto and made a part hereof. All final accompanied by a Contractor and Sub-Contractor Final Payment Waiver, Release and Discharge as in the form attached hereto and made a part hereof. As well as a Contractor Affidavit relative to final payment, a copy of which is attached hereto and made a part of this contract.

-

An official website of New York State.  
Here's how you know 



## Prevailing Wage

[Home](#) > [Prevailing Wage](#)

[Wage Schedule](#) · [Submit Notice Of Award](#) · [Submit Notice Of Project Completion](#)

PRC#: 2025002012

Acceptance Status: Accepted Article 8

Type of Contracting Agency: Town

### Contracting Agency

Town of Schroon  
Ethan Thompson  
Building & Grounds Specialist  
15 Leland Ave  
P.O. Box 578  
Schroon Lake NY 12870  
  
(518) 532-7737  
(518) 532- 9474 Fax  
buildingsgrounds@schroon.net

### Send Reply To

Erica Hedden  
Other  
15 Leland Ave  
P.O. Box 578  
Schroon Lake NY 12870  
  
(518) 532 -7737 Ext: 12  
(518) 532-9474 Fax  
townclerk@schroon.net

### Project Information

<b>Project Title</b>	CONCRETE SIDEWALK REPLACEMENT
<b>Description of Work</b>	removal and replacement of concrete sidewalk; removal and replacement of concrete curb; saw cutting, removal and replacement of asphalt in roadway; saw cutting and site restoration
<b>Contract Id No.</b>	
<b>Project Locations(s)</b>	Varies
<b>Route No / Street Address</b>	
<b>Village / City</b>	
<b>Town</b>	Schroon Lake
<b>State / Zip</b>	NY 12870
<b>Nature of Project</b>	Other Reconstruction, Maintenance, Repair or Alteration
<b>Approximate Bid Date</b>	03/19/2025
<b>Checked Occupation(s)</b>	Construction (Building, Heavy & Highway, Sewer, Water, Tunnel)

### Applicable Counties

Essex

**Department of Labor**

[Accessibility](#)

[Contact](#)

[Language Access](#)

[Privacy Policy](#)

